

People's Democratic Republic of Algeria  
Ministry of Higher Education and Scientific Research



Ibn Khaldoun University of Tiaret  
Faculty of Applied Sciences  
Department of Mechanical Engineering



## **Final Year Project**

Submitted in fulfilment for **Master's** degree

**Field:** Science and Technology

**Sector:** Electromechanical

**Specialty:** Industrial Maintenance

**Title:**

Realization of vibrometers for  
vibration diagnosis: Comparative  
study between the different vibration  
sensors on the market

*Presented by:*

- Ridha Abdelillah HEZLOUN

On 20/06/2023, Under board of examiners composed of:

Dr. Rabah ARARIA	Lecturer class "B" (Univ. Of Ibn Khaldoun)	Chairman
Dr. Halima SLIMANI	Lecturer class "A" (Univ. Of Ibn Khaldoun)	Examiner
Dr. Mohamed BEY	Lecturer class "B" (Univ. Of Ibn Khaldoun)	Examiner
Dr. Aicha ASRI	Lecturer class "B" (Univ. Of Ibn Khaldoun)	Supervisor

2022 - 2023

# **Acknowledgements**

*First of all, I thank ALLAH the Almighty for giving me courage, patience and health during all these years of study.*

*I would like, first of all, to express my gratitude and my sincere thanks to Dr. **ASRI Aicha** lecturer at the University of Tiaret for having supervised and followed this work. Her precious advices, scientific rigor and criticisms have greatly contributed to the realization of this work.*

*I express my sincere thanks to Dr. ARARIA Rabah for having done me the honour of chairing the jury.*

*I also address my best feelings of gratitude to the honourable members of the Jury who did me the honour to accept to examine and to evaluate this work*

*I would also like to thank all professor of Mechanical Engineering Department at the Faculty of Science and Technology, Ibn Khaldun University. You have been a source of inspiration and knowledge. Thank you for everything. This work reflects my deep appreciation for all of your efforts.*

## *Dedication*

*My beloved mother, Yousfi Aisha, who was the private person in my life and who was a strong and inspiring supporter on my journey. With her affection, constant support and great confidence in my abilities, I was able to fulfil my dreams. You were the encouraging voice and shoulder that I relied on in difficult times. I present this note to you as an expression of my deep love and gratitude. I will not forget your kind treatment, tenderness and dedication to my upbringing, and my achievement will not be possible without your unlimited support. May Allah's mercy be upon you, and may He grant you a place in the highest paradise.*

*Ridha*

# List of Figures

<b>Figure I.1:</b> Simple harmonic wave – locus of spring-mass motion with respect to time	5
<b>Figure I.2:</b> Waveform of acceleration, velocity and displacement of mass	6
<b>Figure I.3:</b> Comparison of waves with different amplitudes	6
<b>Figure I.4:</b> Phase relationship between two similar waves	8
<b>Figure I.5:</b> Phase relationship between two similar waves	10
<b>Figure I.6:</b> Power spectral density	11
<b>Figure I.7:</b> The vibration time waveform captured from a moving mechanism	13
<b>Figure I.8:</b> The frequency spectrum of the same signal	13
<b>Figure I.9:</b> Vibration's analysis measurements parameters	14
<b>Figure II.1:</b> Basic vibration measurement scheme	23
<b>Figure II.2:</b> MPU6050 Accelerometer	25
<b>Figure II.3:</b> MPU6050 Module Pinout	25
<b>Figure II.4:</b> ADXL335 Accelerometer	28
<b>Figure II.5:</b> ADXL335 Module Pinout	28
<b>Figure II.6:</b> The piezoelectric accelerometer	29
<b>Figure II.7:</b> LIS3DH Accelerometer	31
<b>Figure II.8:</b> MMA8452Q Accelerometer	33
<b>Figure III.1:</b> Arduino Uno	39
<b>Figure III.2:</b> Technical diagram for the system operation	40
<b>Figure III.3:</b> Fourier Transform from Time Domain to Frequency Domain	41
<b>Figure III.4:</b> Serial Analyzer Settings	42
<b>Figure III.5:</b> Measurement on X Axe Time domain ADXL-335 vs MPU6050	45
<b>Figure III.6:</b> Measurement on Y Axe Time domain ADXL-335 vs MPU6050	46
<b>Figure III.7:</b> Measurement on Z Axe Time domain ADXL-335 vs MPU6050	47
<b>Figure III.8:</b> Measurement on X Axe Frequency domain ADXL-335 vs MPU6050	49
<b>Figure III.9:</b> Measurement on Y Axe Frequency domain ADXL-335 vs MPU6050	49
<b>Figure III.10:</b> Measurement on Z Axe Frequency domain ADXL-335 vs MPU6050	51

## List of Tables

<b>Table II.1:</b> MPU6050 Pinout Configuration	26
<b>Table II.2:</b> ADXL335 Pinout Configuration	28
<b>Table II.3:</b> Comparison between Accelerometer sensors	34
<b>Table III.1:</b> Compression results between ADXL-335 and MPU6050	53

# Table of Contents

<b>Acknowledgements</b>	<b>II</b>
<b>Dedication</b>	<b>III</b>
<b>List of Figures</b>	<b>IV</b>
<b>List of Tables</b>	<b>IV</b>
<b>General introduction</b>	<b>1</b>
<i>Chapter I: Vibration Analysis</i>	
<b>I.1. Introduction</b>	<b>4</b>
<b>I.2. Vibration analysis meaning</b>	<b>4</b>
<b>I.3. Vibration forms</b>	<b>4</b>
<b>I.4. Physical nature of vibration</b>	<b>4</b>
<b>I.4.1. Wave fundamentals</b>	<b>6</b>
<b>I.4.2. Frequency (cycle) / period</b>	<b>7</b>
<b>I.4.3. Wavelength</b>	<b>7</b>
<b>I.4.4. Amplitude</b>	<b>7</b>
<b>I.4.5. Phase</b>	<b>7</b>
<b>I.4.6. Waveforms</b>	<b>8</b>
<b>I.5. Vibration analysis process and application</b>	<b>8</b>
<b>I.6. Vibration analysis principals</b>	<b>8</b>
<b>I.6.1. Time domain</b>	<b>9</b>
<b>I.6.2. Frequency domain</b>	<b>9</b>
<b>I.6.3. Joint domain</b>	<b>9</b>
<b>I.6.4. Modal analysis</b>	<b>9</b>
<b>I.6.5. Time waveform</b>	<b>9</b>
<b>I.6.5.1. Fast Fourier Transform (FFT)</b>	<b>10</b>
<b>I.6.5.2. Phase measurement</b>	<b>10</b>
<b>I.6.5.2. Order analysis</b>	<b>10</b>
<b>I.6.5.3. Power spectral density (PSD)</b>	<b>10</b>
<b>I.6.6. Envelope analysis</b>	<b>11</b>
<b>I.6.7. Orbit</b>	<b>11</b>
<b>I.6.8. Resonance analysis</b>	<b>11</b>
<b>I.7. Vibration measurements</b>	<b>11</b>
<b>I.7.1. Overall level of vibration</b>	<b>11</b>

<b>I.7.2. Spectral analysis of vibration</b>	<b>11</b>
<b>I.7.3. Discrete frequency monitoring</b>	<b>12</b>
<b>I.7.4. Shock pulse monitoring</b>	<b>12</b>
<b>I.7.5. Kurtosis measurement</b>	<b>12</b>
<b>I.7.6. Signal averaging</b>	<b>12</b>
<b>I.8. Vibration characteristics</b>	<b>12</b>
<b>I.9. Vibration’s analysis measurements parameters</b>	<b>13</b>
<b>I.9.1. Acceleration</b>	<b>14</b>
<b>I.9.2. Displacement</b>	<b>14</b>
<b>I.9.3. Velocity</b>	<b>14</b>
<b>I.10. Vibration analysis tools and technologies</b>	<b>15</b>
<b>I.11. Predictive maintenance based on vibration analysis</b>	<b>15</b>
<b>I.11.1. Monitoring</b>	<b>15</b>
<b>I.11.2. Diagnosis</b>	<b>16</b>
<b>I.12. Benefits of continuous vibration monitoring</b>	<b>17</b>
<b>I.12.1. Monitor critical equipment</b>	<b>17</b>
<b>I.12.2. Monitor heavily used equipment</b>	<b>17</b>
<b>I.12.3. Monitor difficult-to-access equipment</b>	<b>17</b>
<b>I.13. Advantages and Limitations</b>	<b>18</b>
<b>I.13.1. Advantages</b>	<b>18</b>
<b>I.13.2. Limitations</b>	<b>18</b>
<b>I.14. Conclusion</b>	<b>18</b>
<b><i>Chapter II : Vibration Sensors Technologies</i></b>	
<b>II.1. Introduction</b>	<b>20</b>
<b>II.2. Vibration sensors</b>	<b>20</b>
<b>II.3. Types of vibrations detectors</b>	<b>20</b>
<b>II.4. Principals and applications of vibrations detectors</b>	<b>21</b>
<b>II.4.1. Operating principal</b>	<b>21</b>
<b>II.4.1.1. Frequency</b>	<b>21</b>
<b>II.4.2.2. Intensity</b>	<b>21</b>
<b>II.4.2. Applications</b>	<b>21</b>
<b>II.5. Machine types that use vibration sensing</b>	<b>22</b>
<b>II.5.1. Water pumps</b>	<b>22</b>
<b>II.5.2. Motors, gearboxes, and belts</b>	<b>22</b>

<b>II.5.3. Fans and compressors</b>	22
<b>II.5.4. Wind turbines</b>	22
<b>II.5.5. Rolling bearings</b>	23
<b>II.6. Vibration measurement diagram</b>	23
<b>II.7. Set up of vibration analysis systems</b>	23
<b>II.7.1. Sensor Mounting</b>	24
<b>II.7.1.1. Wiring</b>	24
<b>II.7.2. Monitoring System Set Up</b>	25
<b>II.8. Some of accelerometer sensors</b>	25
<b>II.8.1. MPU6050 Accelerometer</b>	25
<b>II.8.1.1. MPU6050 Features</b>	26
<b>II.8.1.2. Where to Use MPU6050</b>	26
<b>II.8.1.3. How to Use MPU6050 Sensor</b>	27
<b>II.8.1.4. Applications</b>	27
<b>II.8.2. ADXL335 Accelerometer</b>	27
<b>II.8.2.1. Specification of ADXL335</b>	28
<b>II.8.2.2. How Accelerometer Works</b>	29
<b>II.8.2.3. Features</b>	29
<b>II.8.2.4. Applications</b>	30
<b>II.8.2.5. Alternate options for ADXL335</b>	30
<b>II.8.3. LIS3DH Accelerometer</b>	30
<b>II.8.3.1. How LIS3DH Accelerometer Works</b>	31
<b>II.8.3.2. Features</b>	31
<b>II.8.3.3. Applications</b>	32
<b>II.8.4. MMA8452Q Accelerometer</b>	32
<b>II.8.4.1. How MMA8452Q Accelerometer Works</b>	33
<b>II.8.4.2. Features</b>	33
<b>II.8.4.3. Applications</b>	34
<b>II.9. The difference between the mentioned sensor</b>	34
<b>II.10. Advantages &amp; Disadvantages of Different Types of Vibration Sensors</b>	34
<b>II.10.1. Accelerometers</b>	34
<b>II.10.2. Velocity Sensors</b>	35
<b>II.10.3. Displacement Sensors</b>	35
<b>II.11. Conclusion</b>	35

*Chapter III: Data collector test and analysis*

<b>III.1. Introduction</b>	<b>38</b>
<b>III.2. Operation project mechanism</b>	<b>38</b>
<b>III.3. Materials part</b>	<b>38</b>
<b>III.3.1. Arduino Uno</b>	<b>38</b>
<b>III.3.2. Model installation plan</b>	<b>40</b>
<b>III.3.3. System working principal</b>	<b>40</b>
<b>III.4. Software Part</b>	<b>41</b>
<b>III.4.1. Arduino IDE</b>	<b>41</b>
<b>III.4.2. Python</b>	<b>41</b>
<b>III.4.3. Fast Fourier Transform</b>	<b>41</b>
<b>III.4.4. Serial Analyser</b>	<b>41</b>
<b>III.4.5. Software programs working principal</b>	<b>42</b>
<b>III.4.5.1. Arduino code</b>	<b>42</b>
<b>III.4.5.2. Interfacing Arduino card with the analyser toolbox</b>	<b>43</b>
<b>III.4.5.3. Fast Fourier Transformation</b>	<b>44</b>
<b>III.5. Testing and experimentation of the project</b>	<b>44</b>
<b>III.5.1. Time domain ADXL-335 vs MPU6050</b>	<b>45</b>
<b>III.5.1.1 Measurement on X Axis</b>	<b>45</b>
<b>III.5.1.2 Measurement on Y Axis</b>	<b>46</b>
<b>III.5.1.3 Measurement on Z Axis</b>	<b>47</b>
<b>III.5.2. Frequency domain ADXL-335 vs MPU6050</b>	<b>48</b>
<b>III.5.2.1 Measurement on X Axis</b>	<b>48</b>
<b>III.5.2.2 Measurement on Y Axis</b>	<b>49</b>
<b>III.5.2.3 Measurement on Z Axe</b>	<b>51</b>
<b>III.6. General discussion and results</b>	<b>52</b>
<b>III.6.1. Discussion</b>	<b>52</b>
<b>III.6.2. Results</b>	<b>53</b>
<b>III.7. Conclusion</b>	<b>54</b>
<b>General conclusion</b>	<b>56</b>
<b>Bibliography References</b>	
<b>Abstract</b>	



# List of Abbreviations

**PSD:** Power Spectral Density

**FFT:** Fast Fourier Transform

**STFT:** Short-Time Fourier Transform

**MEMs:** Micro Electro-Mechanical Systems

**DMP:** Digital Motion Processor

**ODR:** Output Data Rates

**IDE:** Integrated Development Environment

**ADC:** Analog Digital Converter

**ODS:** Operating Deflection Shapes

**CMMS:** Computerized Maintenance Management System

**FIFO:** First In, First Out

**I2C:** Inter-Integrated Circuit

**AI:** Artificial Intelligence

**GENERALE**  
**INTRODUCTION**

## **General Introduction**

In the world of electromechanical equipment maintenance, vibration analysis plays a crucial role in various industries. Sensing, measuring, and analyzing vibrations are necessary to ensure the reliability, performance, and safety of machines and systems. Vibration sensors are devices designed to detect and measure vibrations in mechanical systems and convert them into electrical signals for further analysis.

The primary purpose of sensor devices is to monitor and evaluate the dynamic behavior of machines, identifying any abnormal vibrations or changes in vibration patterns. By capturing and analyzing vibration data, engineers can gain valuable insights into the machine's condition, detect potential faults, and take timely maintenance actions to prevent costly breakdowns.

This analysis involves processing and interpreting the vibration data collected by the sensors. It includes studying the time-domain and frequency-domain characteristics of vibration signals and extracting key parameters such as amplitude, frequency, and acceleration. Through advanced analysis techniques such as spectral analysis, time waveform analysis, and multi-directional analysis, engineers can identify root causes of vibrations, diagnose faults, and improve machine performance.

Vibration sensors and analysis find wide applications in various industries, including manufacturing, power generation, transportation, aerospace, and automotive. They are used in monitoring rotating machinery such as motors, pumps, turbines, and generators, as well as structural components such as bridges and buildings. By continuously monitoring vibrations and conducting analysis, potential problems can be detected early, enabling proactive maintenance, reducing downtime, maximizing operational efficiency, and increasing productivity while minimizing costs.

In summary, vibration analysis and monitoring are vital for maintaining the health, reliability, and performance of electromechanical machines. They enable early detection of faults, improve maintenance practices, ensure safety, enhance energy efficiency, contribute to increased productivity, and cost savings.

In the world of modern technology, accelerometer sensing is considered an important tool used to measure velocity or motion changes in objects. Vibration and accelerometer sensors are sensitive devices used to measure and monitor vibrations and motion. While both focus on measuring motion, they differ in their operation and application

Different types of vibration sensors are available in the market, and they can be compared based on several factors. as follows:

**Frequency Range:** It refers to the range of vibrations that the sensor can measure in terms of frequencies. Different sensors are designed for different frequency ranges, and it is important to choose one that suits the specific application.

**Sensitivity:** It measures the sensor's ability to detect and analyse small vibrations. Sensors with high sensitivity are preferred for precise measurement of weak vibrations.

**Accuracy:** It relates to the ability to provide precise and reliable measurements consistently. Sensors should be capable of achieving high accuracy in vibration measurements.

**Interface:** The interface used in the sensor is considered, such as I2C, SPI, or analogue output. The interface should be compatible with the underlying system or platform in which the sensor will be used.

**Power Consumption:** It takes into account the power consumption of the sensor, especially for portable and battery-powered devices. Choosing a sensor with low power consumption is highly important for applications where battery life is crucial.

**Reliability and Compatibility:** The sensor should be reliable and compatible with the application requirements. User reviews and product specifications can help evaluate reliability and compatibility.

When comparing vibration sensors, it is important to consider factors such as cost, size, integration flexibility, and other relevant factors specific to the application.

There are two common sensors used for measuring and monitoring vibrations in electronic applications, namely the **ADXL-335** and **MPU6050** sensors. Here, we will provide a comparison between the two sensors in terms of specifications and applications based on the previously mentioned criteria and some additional features.

The project will be discussed and explained in three important chapters. In the first chapter, we will study the analysis of vibrations and its importance, followed by the technology of vibration sensors. Finally, the project implementation and data collection will be addressed.

# **Chapter I**

## **Vibration Analysis**

## **I.1. Introduction**

Having a strong grasp of the fundamentals of vibration analysis is crucial for effectively identifying and solving issues in electromechanical machinery. A commonly used tool for analysis is switching between the time and frequency domains. It is important to understand the relationship between these domains since the frequency spectrum is obtained from data in the time domain. Typical units of measurement include acceleration, velocity, and displacement, along with additional terms such as peak to peak, peak, and root mean square (rms). Accurately switching between these units and keeping track of these terms is essential.

## **I.2. Vibration analysis meaning**

Vibration analysis is a widely used technique to assess the condition of rotating machinery and structures. By measuring and analyzing the vibrations generated by a machine or structure, it is possible to detect faults or abnormalities such as unbalanced components, misalignment, worn bearings, damaged gear teeth, or cracks in the structure.

Vibration analysis can be done using various techniques, including time-domain analysis, frequency-domain analysis, and modal analysis. Time-domain analysis involves measuring the vibration signal over time and analyzing its waveform and features. Frequency-domain analysis involves analyzing the vibration signal in the frequency domain, typically by using Fourier transforms, to identify the frequencies and amplitudes of the vibration components. Modal analysis involves identifying the natural frequencies and modes of vibration of a structure or machine.

Vibration analysis can provide valuable information about the health and performance of rotating machinery and structures, allowing maintenance and repairs to be carried out proactively, thereby reducing downtime and extending the lifespan of the equipment.

## **I.3. Vibration forms**

Vibrations can be represented in different forms, including displacement, velocity and acceleration. Displacement describes the distance that the measuring point has moved; velocity describes how fast the movement is; and acceleration is self-explanatory [1].

## **I.4. Physical nature of vibration**

A lot can be learned about a machine's condition and possible mechanical problems by noting its vibration characteristics. Referring back to the mass-spring body example, we can learn the characteristics, which characterize a vibration signal and study the characteristics of vibration by plotting the movement of the mass with respect to time as shown in figure I.1 [2]. The motion of the mass from its neutral position, to the top limit of travel, back through its neutral position, to the bottom limit of travel and the return to its neutral position, represents one cycle of motion. This one cycle of motion contains all the information necessary to measure

the vibration of this system. Continued motion of the mass will simply repeat the same cycle [2].

This motion is called periodic and harmonic, where the relationship between the displacement of the mass and time is expressed in the form of a sinusoidal equation:

$$X = X_0 \cdot \sin(\omega t) \quad (1.1)$$

With:

X: displacement at any given instant t;  $X_0$ : maximum displacement;  $\omega = 2\pi f$ ; f:

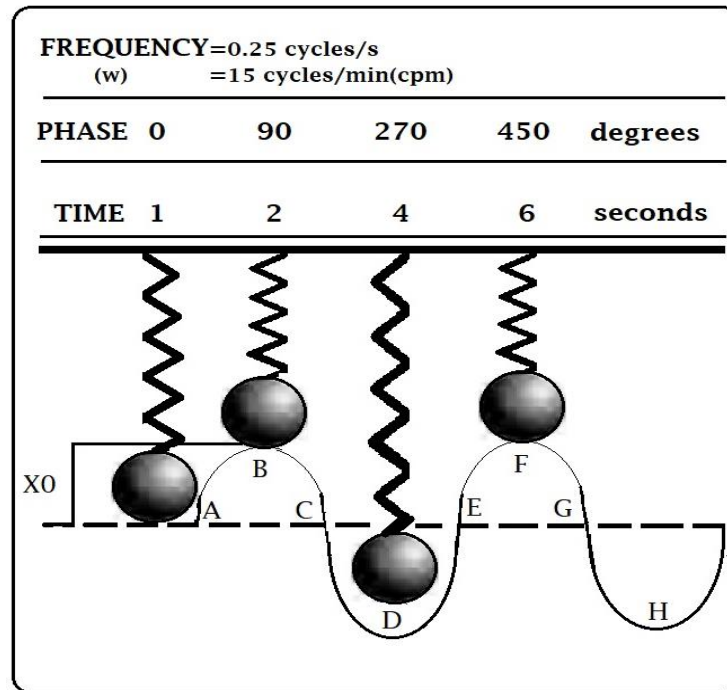

**Figure I.1.** Simple harmonic wave – locus of spring-mass motion with respect to time [2].

As the mass travels up and down, the velocity of the travel changes from zero to a maximum. Velocity can be obtained by time differentiating the displacement equation:

$$V = \frac{dX}{dt} = X_0 \cdot \omega \cdot \cos \omega t \quad (1.2)$$

Similarly, the acceleration 'a' of the mass also varies and can be obtained by differentiating the velocity equation:

$$a = \frac{dV}{dt} = -X_0 \cdot \omega^2 \cdot \sin \omega t \quad (1.3)$$

In figure I.2: displacement is shown as a sine curve; velocity, as a cosine curve; acceleration is again represented by a sine curve.

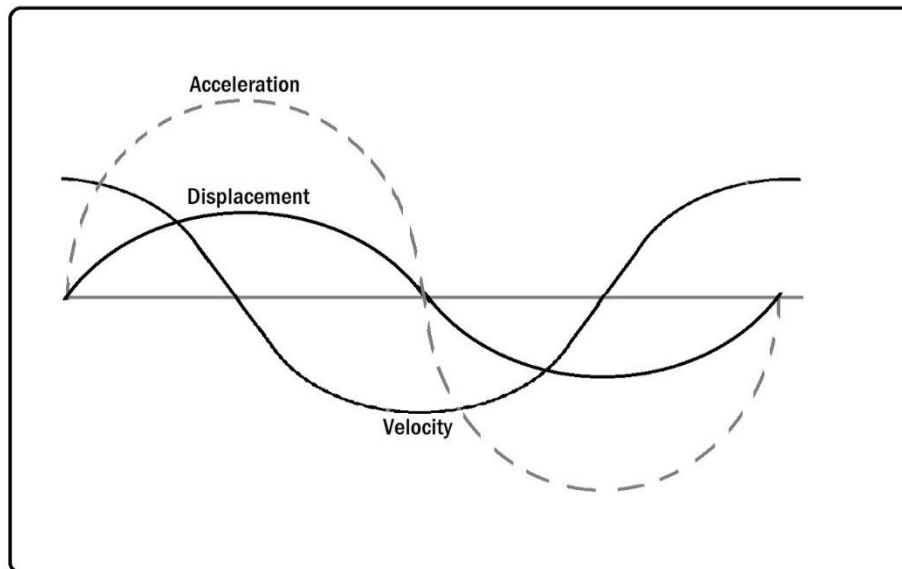

**Figure I.2.** Waveform of acceleration, velocity and displacement of mass in simple harmonic motion [2].

#### I.4.1. Wave fundamentals

Terms such as cycle, frequency, wavelength, amplitude and phase are frequently used when describing waveforms to analysing vibration wave propagation. In Figure I.3, waves 1 and 2 have equal frequencies and wavelengths but different amplitudes. The reference line (line of zero displacement) is the position at which a particle of matter would have been if it were not disturbed by the wave motion.

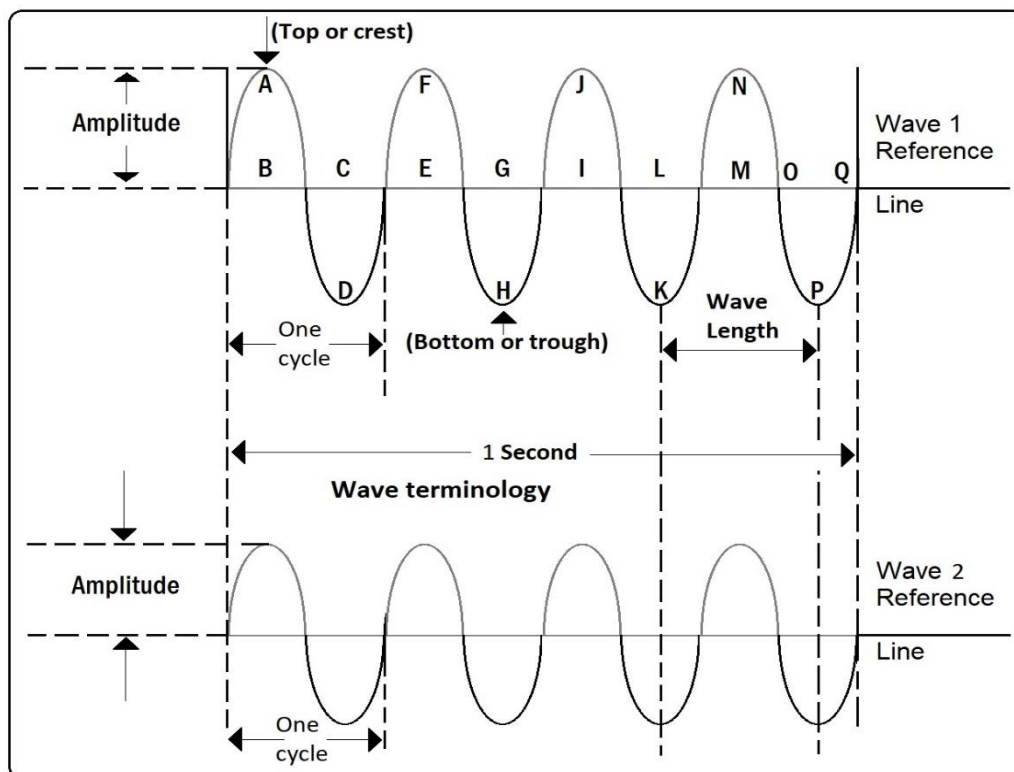

**Figure I.3** Comparison of waves with different amplitudes [2].



Also, there are concepts connected to machine diagnostics using vibration analysis like: discuss waveforms, harmonics, Fourier transforms and overall vibration values.

#### **I.4.2. Frequency (cycle) / period**

The frequency of the wave is the number of complete cycles that occur per unit time and is usually measured in hertz (Hz). The period of the wave is the time taken for one complete cycle to occur and is the reciprocal of the frequency.

As shown in Figure I.3, at point E, the wave begins to repeat with a second cycle, which is completed at point I, a third cycle at point M, etc. The peak of the positive alternation (maximum value above the line) is sometimes referred to as the top or crest, and the peak of the negative alternation (maximum value below the line) is sometimes called the bottom or trough, Therefore, one cycle has one crest and one trough.

#### **I.4.3. Wavelength**

A wavelength is the distance in space occupied by one cycle of a transverse wave at any given instant. If the wave could be frozen and measured, the wavelength would be the distance from the leading edge of one cycle to the corresponding point on the next cycle. Wavelengths vary from a few hundredths of an inch at extremely high frequencies to many miles at extremely low frequencies, depending on the medium. In Figure I.3 (wave 1), the distance between A and E, or B and F, etc., is one wavelength. The Greek letter  $\lambda$  (lambda) is commonly used to signify wavelength.

#### **I.4.4. Amplitude**

Two waves may have the same wavelength, but the crest of one may rise higher above the reference line than the crest of the other, for instance waves 1 and 2 in figure I.3. The height of a wave crest above the reference line is called the amplitude of the wave. The amplitude of a wave gives a relative indication of the amount of energy the wave transmits. A continuous series of waves, such as 'A' through 'Q', having the same amplitude and wavelength, is called a train of waves or wave train.

#### **I.4.5. Phase**

If we consider the two waves as depicted in figure I.4, we find that the waves are identical in amplitude and frequency but a distance of  $T/4$  offsets the crests of the waves. This lag of time is called the phase lag and is measured by the phase angle.

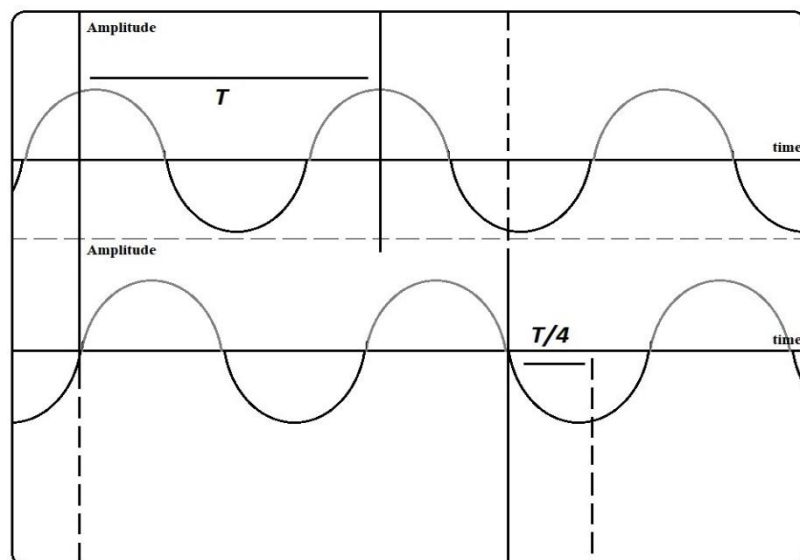

**Figure I.4** Phase relationship between two similar waves [2].

A time lag of  $T$  is a phase angle of  $360^\circ$ , thus a time lag of  $T/4$  will be a phase angle of  $90^\circ$ . In this case we would normally describe the two waves as out of phase by  $90^\circ$ .

#### **I.4.6. Waveforms**

We have seen earlier, under the topic nature of vibrations, that displacement, velocity and acceleration of a spring-mass system in motion can be represented by sine and cosine waves. The waveform is a visual representation (or graph) of the instantaneous value of the motion plotted against time.

#### **I.5. Vibration analysis process and application**

Vibration analysis is a process that monitors the levels and patterns of vibration signals within a component, machinery or structure, to detect abnormal vibration events and to evaluate the overall condition of the test object. Vibration analysis can detect problems such as: Imbalance, Bearing failures, Mechanical looseness, Misalignment, Resonance and natural frequencies, Electrical motor faults, Bent shafts, Gearbox failures, Empty space or bubbles (cavitation) in pumps, Critical speeds

Usually, Vibration analysis is predominantly applied for the condition monitoring on machineries and their key rotating parts [3].

#### **I.6. Vibration analysis principals**

While accelerometers are still the most common tool used to collect vibration data, modern technology and improved sensor technology have allowed for non-contact, high-speed laser sensors that can detect issues accelerometers. This allows for a more accurate and more localized analysis, and opens up vibration analysis to more methodology. Vibration analysis is generally broken down into four principles, and each principle gives you specific information on the working conditions and features of the vibrating parts [4].

**I.6.1. Time domain**

When a vibration signal is picked up from a transducer (device that converts a physical quantity into an electrical signal) and displayed on the screen of an oscilloscope, it's called a waveform. This signal is in the time domain. The time domain is amplitude plotted against time. While most machine vibration issues are detected using spectrum analysis, some types are more easily seen in waveform.

**I.6.2. Frequency domain**

When the waveform discussed earlier is subjected to spectrum analysis, the end result is a picture of frequency vs. amplitude, known as a spectrum. The spectrum is in the frequency domain like the vibration is in the time domain. Most in-depth analysis of machinery vibration is done in the frequency domain or using spectrum analysis.

**I.6.3. Joint domain**

Because vibration signals vary with time, calculating more than one spectrum at once can be useful. To do this, a joint time technique called Gabor-Wigner-Wavelet can be utilized. This technique is used to calculate variations of the fast Fourier transform (discussed below), including short-time Fourier transform (STFT).

**I.6.4. Modal analysis**

Modal analysis takes measured frequency response functions of a piece of machinery and puts them into a computer model. The computer model can be displayed with animations of all the different vibration modes. The model can be adjusted by either adding to or taking away things like mass or stiffness to see the effects.

Outside of these four basic principles lie numerous forms of analysis, calculations and algorithms used to determine different aspects of vibration analysis such [5].

**I.6.5. Time waveform**

A time waveform is acceleration vs. time displayed as tables and plots. Time waveforms show a short time sample of raw vibration, revealing clues to the condition of machinery not always clear in the frequency spectrum. A method of employing time waveform vibration signals as a vibration analysis tool is by using FFT.

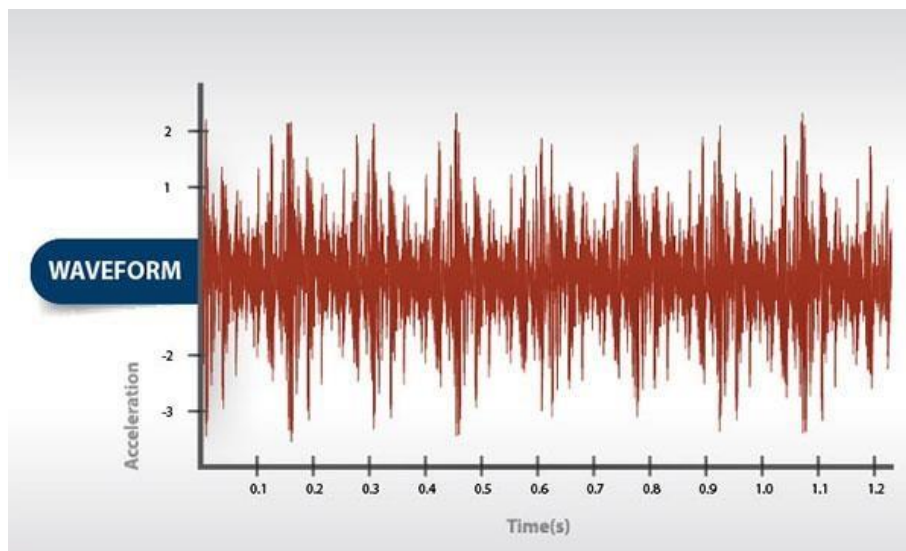

**Figure I.5.** Phase relationship between two similar waves

### **I.6.5.1. Fast Fourier Transform (FFT)**

FFT is defined as an algorithm used to calculate a spectrum from a time waveform. In other words, it's a calculation intended to break down a signal into all its frequencies. If you'll recall time domain and frequency domain discussed above, FFT converts a signal from the time domain into the frequency domain. Fast Fourier transform is most often used for detecting machine faults like misalignment or unbalance.

### **I.6.5.2. Phase measurement**

When talking about vibration analysis, phase is a relative time difference between two signals measured in units of angle as opposed to time. It only works if the two signals being compared are of the same frequency. Phase measurement is used in tandem with FFT to decipher machine faults like loose parts, misalignment and unbalance.

### **I.6.5.2. Order analysis**

Order analysis is a variation of FFT analysis and is mostly used to quantify vibrations of machines with varying revolutions per minute (RPM). In other words, order analysis is frequency analysis where the spectrum's frequency axis is shown in orders of RPM rather than hertz. The term "orders" refers to a frequency that is a multiple of a reference rotational speed. For example, if a vibration signal is equal to twice the frequency of the motor's rotation, the order is two.

### **I.6.5.3. Power spectral density (PSD)**

Power spectral density is calculated by multiplying the amplitude from the FFT by its different forms to normalize it with the frequency bin width (bin width refers to the grouped x-axis values). Think of PSD as looking at "random" vibrations or motion at many different

frequencies. PSD accurately compares random vibration signals that have different signal lengths.

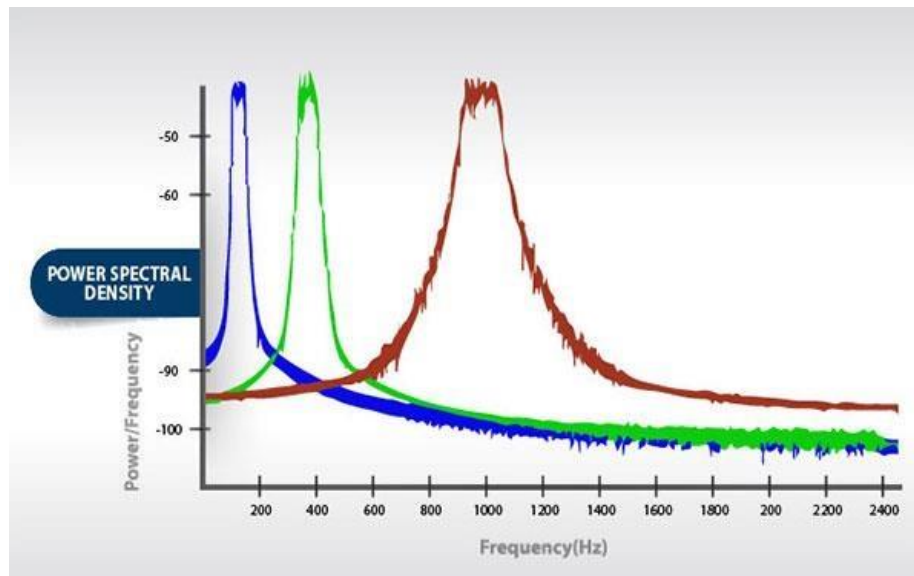

**Figure I.6.** Power spectral density

### **I.6.6. Envelope analysis**

Envelope analysis is a form of vibration analysis that can detect impacts with very low energy often hidden by other vibration signals. It's a popular diagnostic tool for damaged gear teeth and roller bearings.

### **I.6.7. Orbit**

The orbit is defined as a plot of a sleeve bearing journal's centerline. It's measured by placing two probes in the bearing housing 90 degrees apart. Data from these probes can be displayed digitally and used to detect shaft vibrations caused by oil whirl - oil whirling around inside, causing the journal to move.

### **I.6.8. Resonance analysis**

Resonance analysis identifies all the natural vibrations and frequencies in machines. The presence of resonance means high vibration, which could reach damaging levels.

## **I.7. Vibration measurements**

### **I.7.1. Overall level of vibration**

You can think of checking the overall level of vibration like a "rough check" on a machine. By feeling a machine with your hand, you can determine a general sense of whether it is running roughly over a wide frequency band. This initial check is best on rotating machinery, in particular high-speed machines. It's not usually applicable to reciprocating machines [3].

### **I.7.2. Spectral analysis of vibration**

Spectral analysis is the process of transforming a signal from the time domain to the frequency domain. It's often done using FFT. The signal is analysed to determine any

substantial frequencies coming from the machine's components. Where there is a peak in frequency signal, that is the likely source of vibration. Common applications for spectral analysis include the rotational speed of a shaft or how often tooth meshing occurs on a pair of gear wheels.

### **I.7.3. Discrete frequency monitoring**

If you need to monitor a specific component within a machine, discrete frequency monitoring measures the vibration level being generated at a particular frequency which that component would be expected to generate. For example, if you want to look into a certain shaft in a machine, you would turn the monitoring to that machine's rotational speed. Discrete frequency is calculated using the FFT algorithm.

### **I.7.4. Shock pulse monitoring**

Shock pulse monitoring is a predictive maintenance technique that monitors rolling-element bearings with a hand-held instrument. The hand-held instrument gives off a natural frequency that is excited by shocks or vibrations generated by rolling bearings. In other words, when two pieces of metal touch each other while in motion, shock waves develop from the impact, which travels through the metal. This shockwave is used in shock pulse monitoring.

### **I.7.5. Kurtosis measurement**

Kurtosis gives you a measure of the "spikedness" of a random signal. Signals with a higher kurtosis value have more peaks that are greater than three times the signal's root mean square (RMS) value. In vibration analysis, kurtosis is used to monitor fatigue development in rolling bearings with a simple instrument.

### **I.7.6. Signal averaging**

Since signals change with time, signal averaging is important in spectrum analysis because it determines the level of the signal at each frequency. It's particularly important for low-frequency measurements because they need a longer averaging time to get a statically accurate estimate of the spectrum. Signal averaging is often used in the monitoring of a gear in relation to its rotational speed. In this example, signal averaging will show you the cyclic action of each tooth in the gear. If a tooth has a large crack, it would be detected due to its increased flexibility.

## **I.8. Vibration characteristics**

Vibrations can be described both in intensity by amplitude and in periodicity by frequency. Figure I.7 shows the vibration time waveform captured from a moving mechanism. The time waveform is complicated by its speed-varying movement. The peak amplitude can be observed to be approximately 0.12 g, which was induced when the mechanism started to move. The root-mean-square (RMS) value, which represents the "effective" signal level, is roughly 0.007g, as labelled in the graph. Figure I.8 demonstrates the frequency spectrum of the same signal. The

dominant frequency is 30 Hz, which means the majority part of the mechanism movement vibrated 30 times per second [4].

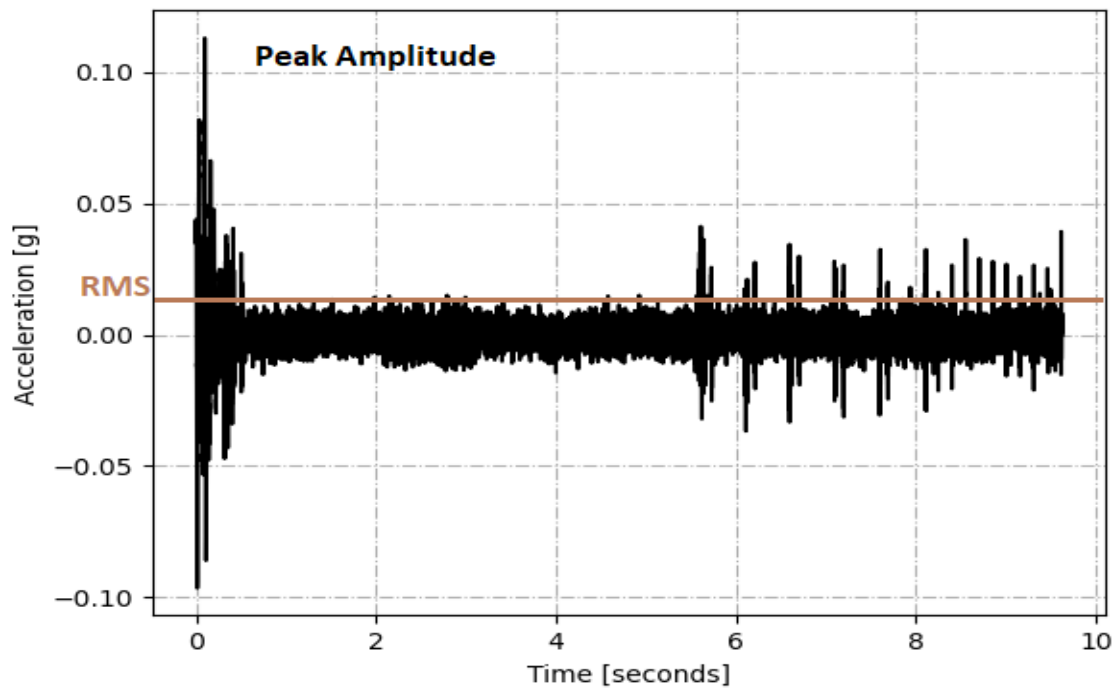

**Figure I.7.** The vibration time waveform captured from a moving mechanism

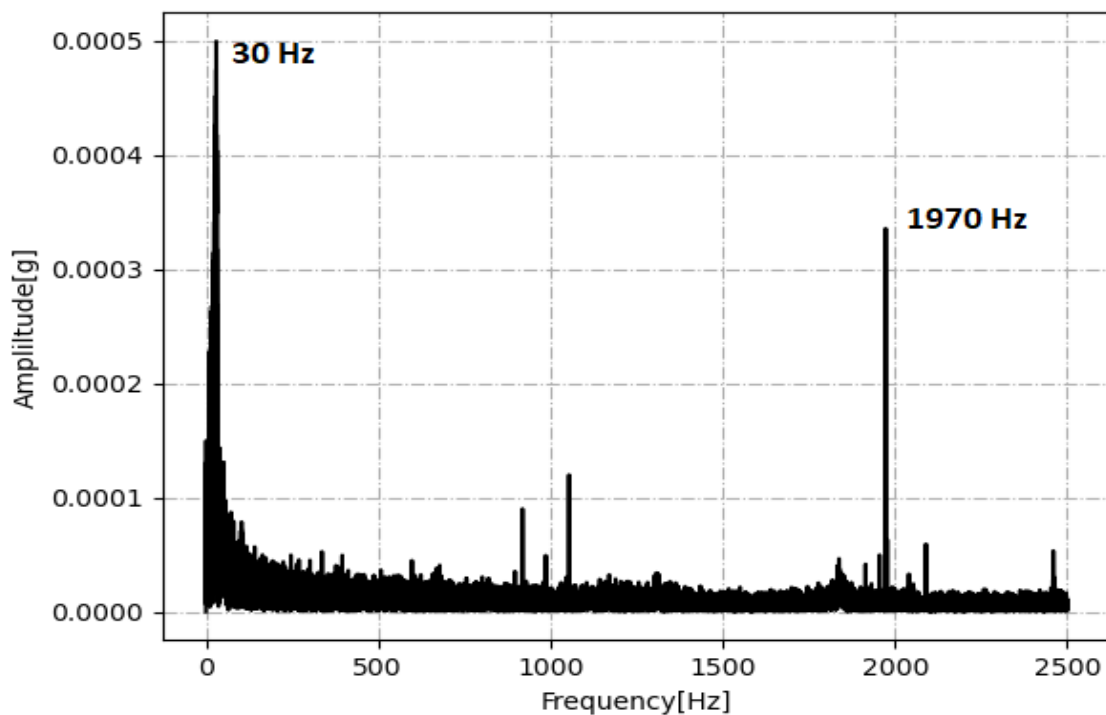

**Figure I.8.** The frequency spectrum of the same signal

### I.9. Vibration's analysis measurements parameters

All of these vibration analysis techniques help to identify three major parameters: acceleration, velocity (RMS) and displacement. Each of these parameters emphasizes certain

frequency ranges in their own way and can be analysed together to diagnose issues. Let's take a look at each parameter [5].

### I.9.1. Acceleration

Acceleration places greater importance on high frequencies. An acceleration signal is not exclusive, however. The acceleration signal can be converted to velocity or displacement.

### I.9.2. Displacement

Just like acceleration places greater importance on high frequencies, displacement looks at low frequencies. Displacement measurements are generally only used when examining the broad picture of mechanical vibrations. You might use displacement to discover unbalance in a rotating part due to a significant amount of displacement at the rotational frequencies of the machine's shaft.

### I.9.3. Velocity

Velocity is related to the destructive force of vibration, making it the most important parameter. It places equal importance on both high and low frequencies. Usually, the RMS value of velocity (measured in the range of 10 to 10,000 Hz) shows the best sign of vibration severity. RMS is calculated by multiplying peak amplitude by 0.707. Below is an example of what acceleration, displacement and velocity look like on the same signal. You can see some peaks at the same frequencies, but each has different amplitudes. This is a good visual of how each parameter assigns different importance to frequency ranges.

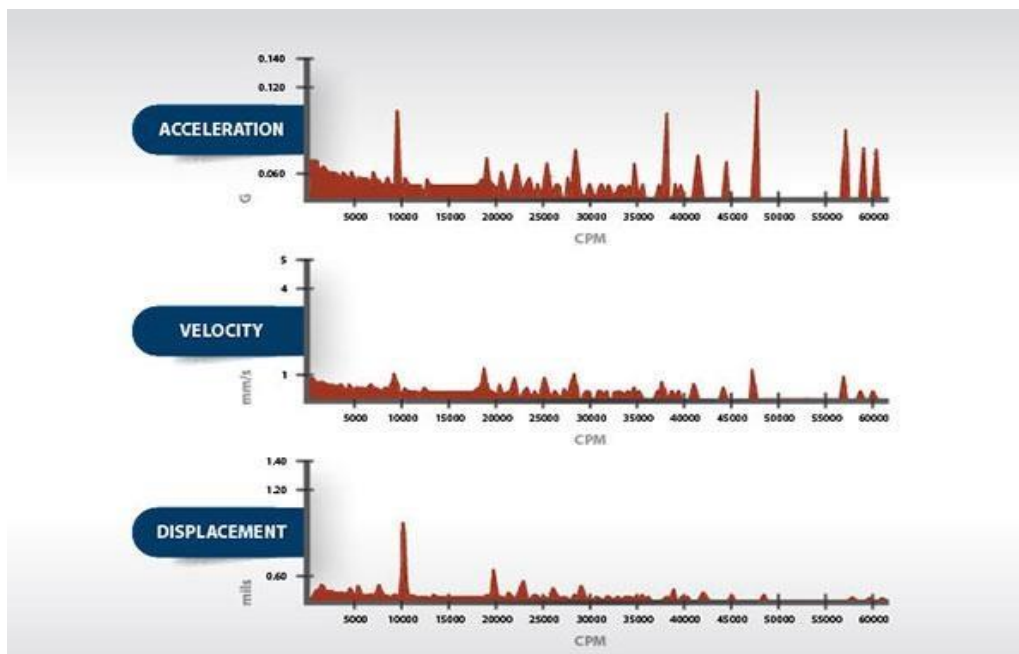

**Figure I.9.** Vibrations analysis measurements parameters



## **I.10. Vibration analysis tools and technologies**

Advanced technology, particularly advances in wireless technology, has greatly improved how vibration analysts collect, interpret and share data. Today, vibration analysers are extremely portable, communicate with smartphones and tablets in real time, and can generate FFT in extremely high resolution. Many vibration instrument companies develop their own apps to communicate with each other.

Another form of advanced technology of vibration analysis interpretation instruments is operating deflection shapes (ODS) 3D simulations of machinery vibrations. In a nutshell, this type of software exaggerates vibration-induced movements in a 3D model so you can visualize the forces impacting your machine while it's running.

Some vibration analysis instrument companies offer databases with thousands of bearing fault frequencies preloaded to help you identify certain fault frequencies for your bearings. Some software can continuously monitor the geometry of your rolling elements and warn you when possible premature failures may occur.

As with most advanced technology, the majority of vibration analysis data is automatically uploaded to the cloud and is available on your mobile device, computer or directly from your browser. This is especially useful if you're performing vibration analysis as a third-party consultant, so you can freely share spectra with your clients [4].

## **I.11. Predictive maintenance based on vibration analysis**

One essential technique for predicting maintenance needs is Vibration Analysis. This method involves measuring and analyzing the vibrations produced by machines or structures to detect potential issues before they become major problems.

### **I.11.1. Monitoring**

As presented above, vibration analysis is used to determine the operating and mechanical condition of equipment. A major advantage is that vibration analysis can identify developing problems before they become too serious and cause unscheduled downtime. This can be achieved by conducting regular monitoring of machine vibrations either on continuous basis or at scheduled intervals.

Regular vibration monitoring can detect deteriorating or defective bearings, mechanical looseness and worn or broken gears. Vibration analysis can also detect misalignment and unbalance before these conditions result in bearing or shaft deterioration. Trending vibration levels can identify poor maintenance practices, such as improper bearing installation and replacement, inaccurate shaft alignment or imprecise rotor balancing.

All rotating machines produce vibrations that are a function of the machine dynamics, such as the alignment and balance of the rotating parts. Measuring the amplitude of vibration at certain

frequencies can provide valuable information about the accuracy of shaft alignment and balance,

The condition of bearings or gears, and the effect on the machine due to resonance from the housings, piping and other structures.

Vibration measurement is an effective, non-intrusive method to monitor machine condition during start-ups, shutdowns and normal operation. Vibration analysis is used primarily on rotating equipment such as steam and gas turbines, pumps, motors, compressors, paper machines, rolling mills, machine tools and gearboxes.

Recent advances in technology allow a limited analysis of reciprocating equipment such as large diesel engines and reciprocating compressors. These machines also need other techniques to fully monitor their operation [2].

A vibration analysis system usually consists of four basic parts:

- Signal pickup(s), also called a transducer;
- A signal analyser;
- Analysis software;
- A computer for data analysis and storage.

These basic parts can be configured to form a continuous online system, a periodic analysis system using portable equipment, or a multiplexed system that samples a series of transducers at:

- Predetermined time intervals;
- Hard-wired and multiplexed systems are more expensive per measurement

position.

The determination of which configuration would be more practical and suitable depends on the critical nature of the equipment, and also on the importance of continuous or semi continuous measurement data for that particular application [2].

### **I.11.2. Diagnosis**

Operators and technicians often detect unusual noises or vibrations on the shop floor or plant where they work on a daily basis. In order to determine if a serious problem actually exists, they could proceed with a vibration analysis. If a problem is indeed detected, additional spectral analyses can be done to accurately define the problem and to estimate how long the machine can continue to run before a serious failure occurs. Vibration measurements in analysis (diagnosis) mode can be cost-effective for less critical equipment, particularly if budgets or manpower are limited. Its effectiveness relies heavily on someone detecting unusual noises or vibration levels. This approach may not be reliable for large or complex machines, or in noisy

parts of a plant. Furthermore, by the time a problem is noticed, a considerable amount of deterioration or damage may have occurred. Another application for vibration analysis is as an acceptance test to verify that a machine repair was done properly. The analysis can verify whether proper maintenance was carried out on bearing or gear installation, or whether alignment or balancing was done to the required tolerances. Additional information can be obtained by monitoring machinery on a periodic basis, for example, once per month or once per quarter. Periodic analysis and trending of vibration levels can provide a subtler indication of bearing or gear deterioration, allowing personnel to project the machine condition into the foreseeable future. The implication is that equipment repairs can be planned to commence during normal machine shutdowns, rather than after a machine failure has caused unscheduled downtime [2].

### **I.12. Benefits of continuous vibration monitoring**

The vibrations methods and tools are great for determining what's wrong with a piece of equipment or machinery (reactive), but they also can be used to catch issues before they cause significant downtime (proactive). Using vibration analysis and monitoring enables to look quantitatively into structural weakness or looseness, rotating component looseness and whether resonance is present.

If implemented properly, continuous vibration monitoring helps you optimize machinery performance. With the use of modern technology, you can take continuous vibration readings on various equipment in real time and have the data sent directly to your smartphone, tablet or desktop via the cloud [3].

#### **I.12.1. Monitor critical equipment**

Critical equipment is any piece of equipment or machine that could cause you to take a big financial hit if a failure were to occur. Continuous vibration monitoring helps detect discrepancies in the vibration spectrum, which can reveal lubrication issues and bearing defects well before major issues appear

#### **I.12.2. Monitor heavily used equipment**

Many plants operate 24/7, only stopping monthly or quarterly for routine maintenance. Stopping more than this can cost the plant a significant amount of money. Online continuous vibration monitoring helps monitor the condition of heavily used machinery or troubled machinery and sends alerts when that condition changes.

#### **I.12.3. Monitor difficult-to-access equipment**

Performing maintenance on equipment located in hard-to-reach places is difficult. Machines on rooftops, cooling towers and those operating in high-temperature areas can be continuously monitored for vibration abnormalities, allowing maintenance to be done at a convenient time.

This prevents unplanned downtime and keeps maintenance staff from accessing these locations unnecessarily.

### **I.13. Advantages and Limitations**

#### **I.13.1. Advantages**

- Real-time reaction to the change of health conditions;
- Supports remote condition monitoring;
- Well-established processing and signal analysis methods/algorithms for predictive maintenance;
- Supported by various sensors commercially available for different operational conditions.

#### **I.13.2. Limitations**

- Difficult to conduct fault localisation;
- Difficult to monitoring crack propagation;
- High requirements for proper system setup.

### **I.14. Conclusion**

Vibration analysis for machine monitoring and diagnosis has become cheaper and cheaper thanks to the emerging technology and development in the data acquisition process and signal processing techniques including the instrument applied. Nowadays, even inexperienced users can conduct effective vibration monitoring without the presence of an expert.

In this section we have provided an overview of various concepts related to vibration analysis and their relationship to proactive maintenance.

# **Chapter II**

## **Vibration Sensors Technologies**

## II.1. Introduction

At present in the industry like research and development, the ability of monitoring, measuring as well as analyzing the vibration is very important. Unfortunately, the suitable techniques for making a measurement system for vibration with precise & repeatable are not always clear to researchers with the shades of test tools & analysis of vibration. There are some challenges related while measuring the vibration which includes a selection of suitable component, the configuration of the system, signal conditioning, analysis of waveform and setup. This chapter discusses what is a vibration sensor, working principle, types, and applications.

## II.2. Vibration sensors

A vibration sensor, or vibration detector, measures vibration levels in machinery for screening and analysis. Maintenance teams use industrial vibration sensors for condition monitoring, giving them insight into the magnitude and frequency of vibration signals. Vibration sensors often provide overall vibration levels, indicating whether your asset is under stress, but they can also give more sophisticated readings [5].

### II.3. Types of vibrations detectors

- **Accelerometers:** An accelerometer measures changes in velocity and converts them to electronic signals. The most popular type of vibration sensor.
- **Handheld Vibration Analysers:** A vibration analyser is handheld meter that often incorporates other vibration sensor technology to provide instant readings, perform measurements in the field, and take readings for later vibration analysis.
- **Eddy Current / Capacitive Displacement:** Eddy current sensors allow you to measure displacement without touching an asset. The sensor measures displacement by generating magnetic fields to measure relative motion.
- **Laser Displacement:** Laser displacement is another no-contact method for measuring vibration, triangulating the displacement of an asset with laser beams.
- **Strain Gauges:** A strain gauge is a foil with a conductive grid. When the asset under test vibrates, the grid's resistance changes – undergoing “strain.” This strain helps to measure vibration
- **Microphones:** Microphone sensors detect vibration with advanced acoustic techniques, measuring frequencies of vibration that might otherwise be difficult to detect. They are generally not sophisticated enough to measure values or determine sources of vibration.
- **Gyroscopes (MEMs):** A gyroscope determines velocity and is often used in conjunction with an accelerometer for vibration measurement.

## **II.4. Principals and applications of vibrations detectors**

### **II.4.1. Operating principal**

A vibration sensor either connects directly to an asset or monitors it wirelessly. Once placed, it will detect vibrations from the asset through various means, depending on the type of sensor (more on that below). Over time, you'll get two types of data from the device [6].

#### **II.4.1.1. Frequency**

The first type of data is the frequency, or how often the vibration occurs. By tracking when spikes in vibration happen in a given asset, you'll be able to pinpoint root causes.

#### **II.4.2.2. Intensity**

The second point of data you'll get is the intensity of the vibration as it occurs. The more vibration you have from a piece of equipment, the higher the intensity measurements will be. As these two types of data are collected, your CMMS will log them into the asset's history, which can then be used as a point of comparison. As malfunctions occur, they'll reflect in the data, and your system will be able to predict future failures and malfunctions by comparing the current data with past trends.

### **II.4.2. Applications**

Vibration sensors are very useful in all industries wherever there is a possibility of vibration and need to monitor the same for improved asset performance. In general, the following industries find a wide application of vibration sensors [7].

- Oil and gas
- Mining
- Aerospace
- Food and beverage
- Pulp and paper
- Refining, chemical, petrochemical, and other processing industry.
- Metalworking
- Automotive & Transportation
- Power generation
- Certain manufacturing industries
- Wind power and other renewable power
- Cement
- Research and Development

There are several industry standards that govern vibration measurement for industries. Some of those are:

- ISO 4866

ISO 4866 is a standard published by the International Organization for Standardization (ISO). It is titled "Mechanical vibration and shock - Vibration of stationary structures - Guidelines for the measurement of vibrations and evaluation of their effects on structures." This standard provides guidelines for measuring vibrations and evaluating their effects on stationary structures. It includes information on measurement techniques, instrumentation, and assessment criteria for different types of structures

- ISO 20816

ISO 20816 is another standard published by the International Organization for Standardization (ISO). Its full title is "Mechanical vibration - Measurement and evaluation of machine vibration - Part 1: General guidelines." This standard provides general guidelines for the measurement and evaluation of mechanical vibration in machines. It covers various aspects such as measurement techniques, instrumentation, data processing, and interpretation of vibration data. ISO 20816 helps to ensure consistent and reliable assessment of machine vibration levels for different applications.

- AS 2625.1

AS 2625.1 is a standard published by Standards Australia. Its title is "Gas distribution networks - Part 1: Asset management." This standard specifically focuses on the asset management aspects of gas distribution networks. It provides guidelines and best practices for managing the assets within gas distribution networks, including design, construction, operation, and maintenance. AS 2625.1 aims to ensure the safe and efficient operation of gas distribution networks by outlining the processes and requirements for managing their assets effectively.

These standards play an essential role in promoting consistency, safety, and quality in their respective domains, providing guidance and best practices for various industries and organizations.

## **II.5. Machine types that use vibration sensing**

Vibration sensors are highly effective at monitoring the health of a wide range of machines. In fact, 90% of machines can benefit from vibration monitoring. Following are a few examples [6].



### **II.5.1. Water pumps**

Water pumps are important pieces of equipment in the water and wastewater industry. If water pumps and condensers stop working, they can leave thousands of people without access to clean water and cause extensive damage to the environment.

Vibration sensors help make sure the bearings, motors, and fans in water pumps and condensers operate smoothly, providing advanced warning of potential issues if readings start to get a bit rough.

### **II.5.2. Motors, gearboxes, and belts**

Any asset with a motor, gearbox, or belt system relies on rotating components, which means vibration monitoring can play a vital role in condition monitoring for those machines.

Monitoring vibrations in these types of systems can prevent minor imbalances in individual machines from developing into major disruptions in the entire system. For instance, the food and beverage industry makes use of chillers with motors

### **II.5.3. Fans and compressors**

Fans and compressors—such as those used in most industrial machines and ventilation systems—make use of rotating equipment that must run smoothly. If a fan or compressor system starts showing signs of imbalance or wear, that will reflect in any vibration data collected, allowing maintenance teams to detect issues in the system early enough to minimize repair costs.

### **II.5.4. Wind turbines**

Perhaps the largest pieces of rotating equipment are wind turbines, which rotate anywhere between 5 rpm and 30rpm. Making routine checks on wind turbines can be time consuming and dangerous, given the heights—in excess of 300 feet—and rotor movements involved.

To cut down on the costs of monitoring wind turbines and preserve the safety of technicians, vibration monitoring can provide consistent, accurate data on the current health of each turbine in a wind farm. If an imbalance shows up, that's a signal to send a technician out to fix it.

### **II.5.5. Rolling bearings**

Most pieces of rotating equipment use rolling bearings to keep parts moving. Mixers, turbines, motors, and wheel axles make use of bearings to keep everything spinning smoothly. To keep doing their job, rolling bearings need lubrication. If they go too long without it, they grind and wear out, causing extra vibration in the asset. By the time that grinding becomes audible to human ears, it's often too late—the bearing system likely needs replacement.

Tracking the vibration caused by bearing systems can alert maintenance teams to a machine's need for oiling, preventing the cost of more expensive repairs later on.

## II.6. Vibration measurement diagram

Figure II.1 illustrates the basic features of a vibration measurement scheme. In this figure, the motion (or dynamic force) of the vibrating body is converted into an electrical signal by the vibration transducer or pickup. In general, a transducer is a device that transforms changes in mechanical quantities (such as displacement, velocity, acceleration, or force) into changes in electrical quantities (such as voltage or current). Since the output signal (voltage or current) of a transducer is too small to be recorded directly, a signal conversion instrument is used to amplify the signal to the required value. The output from the signal conversion instrument can be presented on a display unit for visual inspection, or recorded by a recording unit, or stored in a computer for later use. The data can then be analysed to determine the desired vibration characteristics of the machine or structure [8].

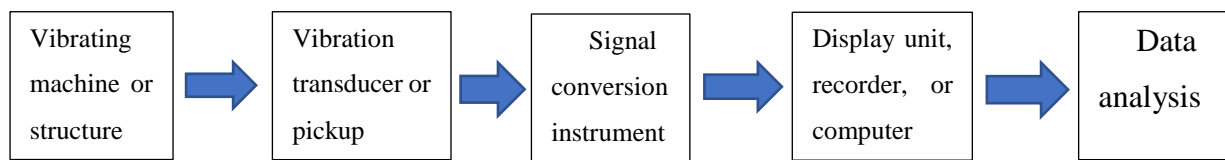

**Figure II.1:** Basic vibration measurement scheme.

The following considerations often dictate the type of vibration-measuring instruments to be used in a vibration test: (1) expected ranges of the frequencies and amplitudes, (2) sizes of the machine/structure involved, (3) conditions of operation of the machine/equipment/structure, and (4) type of data processing used (such as graphical display or graphical recording or storing the record in digital form for computer processing).

## II.7. Set up of vibration analysis systems

In vibration analysis, evaluating and determining the mounting location of an individual sensor is critical. Incorrect mounting of a vibration sensor can lead to unreliable results, so correct mounting of the sensor is vital to ensure accuracy and consistency. A successful installation of a vibration sensor can be accomplished with an understanding of that sensor's requirements, capabilities, and limitations.

Sensors should be mounted as close to the source of vibration as possible and to a smooth, unpainted, flat area that is oil and grease free and larger than the base of the sensor itself. To ensure that the sensor detects faults in machine components, it should be mounted in the location with the proper orientation in order to allow for the correct vibration direction to be monitored effectively (horizontal, vertical, and/or axial movement).

Fundamentally, setting up a vibration monitoring system consists of three parts [9]:

### **II.7.1. Sensor Mounting**

Correctly mounting the sensor onto the system is critical to ensure accurate measurements. Generally, the nearer you place the vibration sensor to the shaft supports (bearings), the better the sensor will measure vibrations – particularly the high-frequency signals.

You can use several mounting methods for accelerometers and velocity sensors – such as studs, adhesive mounts, flat or 2-poled magnets, or probe tips. The mounting method will affect the frequency range the sensor is able to measure (accelerometers), which is particularly important with high frequencies. Displacement sensors are generally screwed into place through the casing to monitor the relative vibration of the shaft, with the proper gap distance for that sensor. Displacement sensors used for vibration and speed/phase reference monitoring require rigid mounting when attaching the sensor to the machine.

#### **II.7.1.1. Wiring**

Good wiring or cabling is also integral to an efficient vibration measurement system. When it comes to cabling, cable length, and capacitance, routing, grounding, and anchoring are the most critical. There is a maximum length for accelerometers before the signal content starts to diminish. The capacitance of a cable increases with length; therefore, the sensor's final output will combine its own capacitance with the cable capacitance. Therefore, displacement sensors all have fixed length cables. Routing is the process of determining the path of the cable from the sensor to the acquisition system. Proper routing is necessary because when the cable is routed close to other electronic devices, electromagnetic interference and electro-static discharge from these devices may interfere with the readings from the sensor. Instrumentation cable should be routed in designated instrumentation cable trays and should never be parallel to power cables. It is also important to avoid cable ground looping. Besides these points, cabling or routing should start with properly shielded cables.

### **II.7.2. Monitoring System Set Up**

Choosing a monitoring system is straight forward as it depends on the sensor being used and its cable. Setting up monitoring system is all about ensuring repeatability and ensuring uninterrupted connection. A monitoring system has two interfaces. The first interface is between the sensor and the data acquisition and processing unit. The second interface sits between the data acquisition and processing system and a network where there are other system and users. Usually, the manufacturer will provide a detailed guide on how to configure the monitoring system properly.

## II.8. Some of accelerometer sensors

### II.8.1. MPU6050 Accelerometer

The MPU6050 module is a Micro Electro-Mechanical Systems (MEMS) which consists of a 3-axis Accelerometer and 3-axis Gyroscope inside it. This helps us to measure acceleration, velocity, orientation, displacement and many other motions related parameter of a system or object [10].



**Figure II.2:** MPU6050 Accelerometer

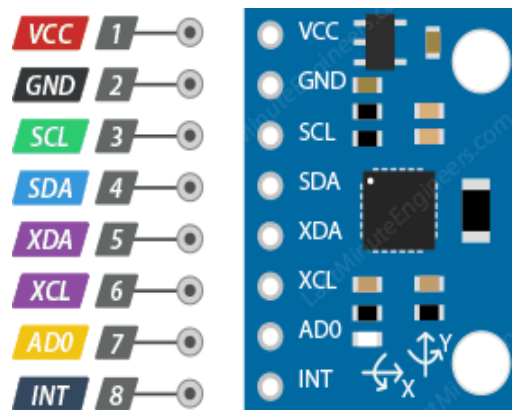

**Figure II.3:** MPU6050 Module Pinout

**Table II.1: MPU6050 Pinout Configuration**

Pin Number	Pin Name	Description
1	VCC	Provides power for the module, can be +3V to +5V. Typically +5V is used
2	GND	Connected to Ground of system
3	Serial Clock (SCL)	Used for providing clock pulse for I2C Communication
4	Serial Data (SDA)	Used for transferring Data through I2C communication
5	Auxiliary Serial Data	Can be used to interface other I2C modules with MPU6050. It is optional
6	Auxiliary Serial Clock	Can be used to interface other I2C modules with MPU6050. It is optional
7	AD0	If more than one MPU6050 is used a single MCU, then this pin can be used to vary the address
8	Interrupt (INT)	Interrupt pin to indicate that data is available for MCU to read.

### II.8.1.1. MPU6050 Features

- MEMS 3-axis accelerometer and 3-axis gyroscope values combined
- Power Supply: 3-5V
- Communication: I2C protocol
- Built-in 16-bit ADC provides high accuracy
- Built-in DMP provides high computational power
- Can be used to interface with other IIC devices like magnetometer
- Configurable IIC Address
- In-built Temperature sensor

### II.8.1.2. Where to Use MPU6050

The MPU6050 is a Micro Electro-Mechanical Systems (MEMS) which consists of a 3-axis Accelerometer and 3-axis Gyroscope inside it. This helps us to measure acceleration, velocity, orientation, displacement and many other motion related parameter of a system or object. This module also has a (DMP) Digital Motion Processor inside it which is powerful enough to perform complex calculation and thus free up the work for Microcontroller.

The module also has two auxiliary pins which can be used to interface external IIC modules like a magnetometer, however it is optional. Since the IIC address of the module is configurable more than one MPU6050 sensor can be interfaced to a Microcontroller using the AD0 pin. This module also has well documented and revised libraries available hence it's very easy to use with famous platforms like Arduino. So if you are looking for a sensor to control motion for

your RC Car, Drone, Self-balancing Robot, Humanoid, Biped or something like that then this sensor might be the right choice for you [10].

### II.8.1.3. How to Use MPU6050 Sensor

The hardware of the module is very simple; it actually comprises of the MPU6050 as the main components as shown above. Since the module works on 3.3V, a voltage regulator is also used. The IIC lines are pulled high using a 4.7k resistor and the interrupt pin is pulled down using another 4.7k resistor.

The MPU6050 module allows us to read data from it through the IIC bus. Any change in motion will be reflected on the mechanical system which will in turn vary the voltage. Then the IC has a 16-bit ADC which it uses to accurately read these changes in voltage and stores it in the FIFO buffer and makes the INT (interrupt) pin to go high. This means that the data is ready to be read, so we use a MCU to read the data from this FIFO buffer through IIC communication. As easy as it might sound, you may face some problem while actually trying to make sense of the data However there are lots of platforms like Arduino using which you can start using this module [10].

### II.8.1.4. Applications

- Used for IMU measurement
- Drones / Quad copters
- Self-balancing robots
- Robotic arm controls
- Humanoid robots
- Tilt sensor
- Orientation / Rotation Detector

### II.8.2. ADXL335 Accelerometer

An accelerometer is an electromechanical device that will measure acceleration force. It shows acceleration, only due to cause of gravity i.e. g force. It measures acceleration in g unit. On the earth, 1g means acceleration of 9.8 m/s<sup>2</sup> is present. On moon, it is 1/6th of earth and on mars it is 1/3rd of earth. Accelerometer can be used for tilt-sensing applications as well as dynamic acceleration resulting from motion, shock, or vibration [11].

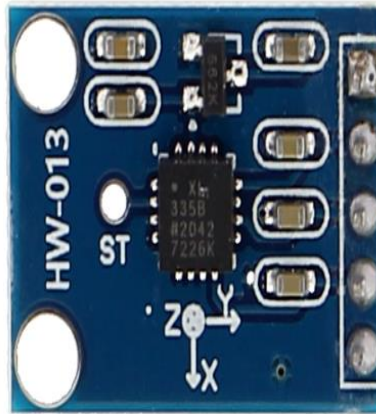

Figure II.4: ADXL335 Accelerometer

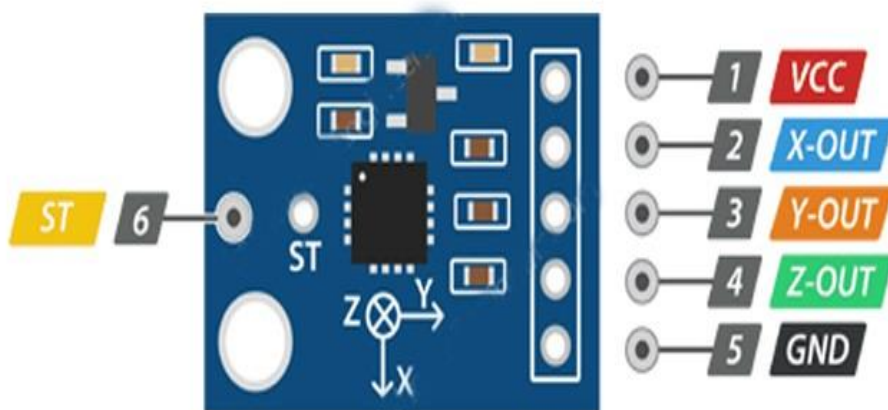

Figure II.5: ADXL335 Module Pinout

Table II.2: AXDL335 Pinout Configuration

Pin Number	Pin Name	Description
1	VCC	Power supply pin i.e. connect 5V here.
2	X_OUT	X axis analog output.
3	Y_OUT	Y axis analog output.
4	Z_OUT	Z axis analog output.
5	Ground	Ground pin i.e. connect ground here.

### II.8.2.1. Specification of ADXL335

- Supply Voltage: 2.8V to 3.6V
- Current Consumption: 320uA
- Sensitivity: 300mV/g
- Bandwidth: 3Hz to 5kHz

- Dynamic Range:  $\pm 3g$
- Operating Temperature:  $-40^{\circ}\text{C}$  to  $+85^{\circ}\text{C}$
- Package Type: Surface Mount Plastic Package (LFCSP)
- Pin Configuration: 5 Pin, 1.27mm Pitch
- Output Type: Voltage Output
- Interface: SPI/I2C
- Output Range: 0V to Vcc
- Storage Temperature:  $-65^{\circ}\text{C}$  to  $+150^{\circ}\text{C}$

### II.8.2.2. How Accelerometer Works

Basically, an accelerometer is an apparatus that detects vibrations and accelerations. As we already know that acceleration is the change of velocity in a body or an object concerning time. So, an accelerometer senses these vibrations produced by that body and used this for the change of direction. It senses the acceleration and vibration and transforms them into pressure or stress; we know this phenomenon as the piezoelectric effect. After that, this energy is then get converted into an electrical voltage which is needed to drive the device. In other words, it transforms mechanical energy (basically, vibrations) into electrical energy [12].

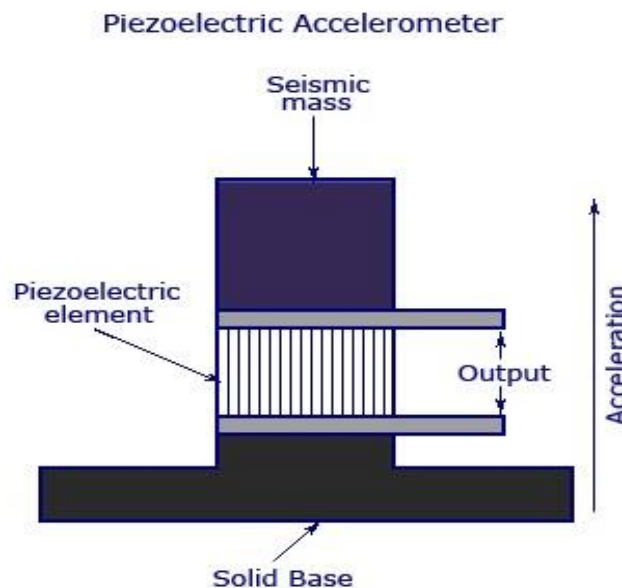

**Figure II.6:** The piezoelectric accelerometer

### II.8.2.3. Features

- 3-axis sensing
- Small, low-profile package
- $4\text{ mm} \times 4\text{ mm} \times 1.45\text{ mm}$  LFCSP
- Low power:  $350\ \mu\text{A}$  (typical)



- Single-supply operation: 1.8 V to 3.6 V
- 10,000 g shock survival
- Excellent temperature stability
- BW adjustment with a single capacitor per axis
- RoHS/WEEE lead-free compliant

#### II.8.2.4. Applications

- Cost sensitive, low power, motion- and tilt-sensing
- Mobile devices
- Gaming systems
- Disk drive protection
- Image stabilization
- Sports and health devices

#### II.8.2.5. Alternate options for ADXL335 [11]

- **ADXL345:** This is a newer version of the ADXL335 and has more advanced features such as a higher range, better resolution, and an on-board FIFO buffer.
- **LIS3DH:** This is a low power accelerometer that is commonly used in wearable devices. It has a range of  $\pm 2g$  to  $\pm 16g$  and a high-resolution mode.
- **MMA8452Q:** This is a high-performance accelerometer that is commonly used in mobile devices. It has a range of  $\pm 2g$  to  $\pm 8g$  and can operate at up to 800 Hz.
- **MPU-6050:** This is an integrated accelerometer and gyroscope module. It is commonly used in motion control and stability applications and has a range of  $\pm 2g$  to  $\pm 16g$

#### II.8.3. LIS3DH Accelerometer

The LIS3DH is an ultra-low-power high performance three-axis linear accelerometer belonging to the “nano” family, with digital I2C/SPI serial interface standard output. The device features ultra-low-power operational modes that allow advanced power saving and smart embedded functions.

The LIS3DH has dynamically user-selectable full scales of  $\pm 2g/\pm 4g/\pm 8g/\pm 16g$  and is capable of measuring accelerations with output data rates from 1 Hz to 5.3 kHz. The self-test capability allows the user to check the functioning of the sensor in the final application. The device may be configured to generate interrupt signals using two independent inertial wake-up/free-fall events as well as by the position of the device itself. Thresholds and timing of interrupt generators are programmable by the end user on the fly. The LIS3DH has an integrated 32-level first-in, first out (FIFO) buffer allowing the user to store data in order to limit intervention by the host processor. The LIS3DH is available in small thin plastic land grid array package

(LGA) and is guaranteed to operate over an extended temperature range from  $-40\text{ }^{\circ}\text{C}$  to  $+85\text{ }^{\circ}\text{C}$ . [13]



**Figure II.7:** LIS3DH Accelerometer

### II.8.3.1. How LIS3DH Accelerometer Works

The LIS3DH Accelerometer Sensor block measures linear acceleration, voltages on external input pins (ADC1, ADC2 and ADC3) of the sensor, and temperature using the LIS3DH Accelerometer sensor interfaced with the C2000 board.

The block also provides the option to enable the high pass filter, FIFO and FIFO interrupt. An interrupt is generated if Generate data ready interrupt is selected. After selecting Generate data ready interrupt, if FIFO is disabled data ready interrupt is generated and if FIFO is enabled FIFO interrupt is generated.

The block outputs status of acceleration measurement, specified as a value 0, 1, or 2. The value 0 indicates that the data read is new, 1 indicates that the data read is not new, and 2 indicates that the data is overwritten.

The block outputs single / double click axis as a 1-by-3 vector. The click axis provides information of the axis, on which click is detected. The axis value displays 1 when a click is detected otherwise it displays 0.

The block supports inertial wake-up, free-fall, 6D position, 6D movement, 4D position and 4D movement recognition. The block outputs inertial wake-up axis as a 1-by-3 vector. This provides information of the axis, on which inertial wake-up is detected. The 6D position axis and 6D movement axis are of size 1-by-6. The 4D position and 4D movement axis are of size 1-by-4. The status contains the information about the axis, on which the detection is recognized. The status value displays 1 when the configured detection is recognized on the selected axis, otherwise it displays 0 [14].

### II.8.3.2. Features

- Wide supply voltage, 1.71 V to 3.6 V
- Independent IO supply (1.8 V) and supply voltage compatible

- Ultra-low-power mode consumption down to 2 $\mu$ A
- $\pm 2g/\pm 4g/\pm 8g/\pm 16g$  dynamically selectable full scale
- I<sup>2</sup>C/SPI digital output interface
- 16-bit data output
- 2 independent programmable interrupt generators for free-fall and motion detection
- 6D/4D orientation detection
- Free-fall detection
- Motion detection
- Embedded temperature sensor
- Embedded self-test
- Embedded 32 levels of 16-bit data output FIFO
- 10000 g high shock survivability
- ECOPACK®, RoHS and “Green” compliant
- Display orientation
- Gaming and virtual reality input devices
- Impact recognition and logging
- Vibration monitoring and compensation

### II.8.3.3. Applications

- Motion activated functions
- Free-fall detection
- Click/double-click recognition
- Intelligent power saving for handheld devices
- Pedometers
- Display orientation
- Gaming and virtual reality input devices
- Impact recognition and logging
- Vibration monitoring and compensation

### II.8.4. MMA8452Q Accelerometer

The MMA8452Q accelerometer is a 3-axis accelerometer that supports three selectable sensing ranges:  $\pm 2g$ , 4g, or 8g. It has features like orientation detection, single and double-tap sensing, and low power modes [15].

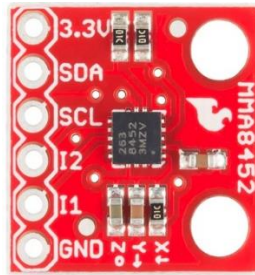

**Figure II.8:** MMA8452Q Accelerometer

#### II.8.4.1. How MMA8452Q Accelerometer Works

The MMA8452Q is a smart, low-power, three-axis, capacitive, micro machined accelerometer with 12 bits of resolution. This accelerometer is packed with embedded functions with flexible user programmable options, configurable to two interrupt pins. Embedded interrupt functions allow for overall power savings relieving the host processor from continuously polling data.

The MMA8452Q has user selectable full scales of  $\pm 2$  g/ $\pm 4$  g/ $\pm 8$  g with high-pass filtered data as well as non-filtered data available real-time. The device can be configured to generate inertial wakeup interrupt signals from any combination of the configurable embedded functions allowing the MMA8452Q to monitor events and remain in a low-power mode during periods of inactivity. The MMA8452Q is available in a 16-pin QFN, 3 mm x 3 mm x 1 mm package [15].

#### II.8.4.2. Features

- 1.95 V to 3.6 V supply voltage
  - 1.6 V to 3.6 V interface voltage
  - $\pm 2$  g/ $\pm 4$  g/ $\pm 8$  g dynamically selectable full-scale
  - Output data rates (ODR) from 1.56 Hz to 800 Hz
  - 99  $\mu\text{g}/\sqrt{\text{Hz}}$  noise
  - 12-bit and 8-bit digital output
  - I<sup>2</sup>C digital output interface
  - Two programmable interrupt pins for six interrupt sources
  - Three embedded channels of motion detection
1. Freefall or motion detection: one channel
  2. Pulse detection: one channel
  3. Transient detection: one channel
    - Orientation (portrait/landscape) detection with set hysteresis
    - Automatic ODR change for auto-wake and return to sleep

- High-pass filter data available real-time
- Self-test
- Current consumption: 6 $\mu$ A to 165 $\mu$ A

### II.8.4.3. Applications

- E-compass applications
- Static orientation detection (portrait/landscape, up/down, left/right, back/front position identification)
- Notebook, e-reader, and laptop tumble and freefall detection
- Real-time orientation detection (virtual reality and gaming 3D user position feedback)
- Real-time activity analysis (pedometer step counting, freefall drop detection for HDD, dead-reckoning GPS backup)
- Motion detection for portable product power saving (auto-sleep and auto-wake for cell phone, PDA, GPS, gaming)
- Shock and vibration monitoring (mechatronic compensation, shipping and warranty usage logging)
- User interface (menu scrolling by orientation change, pulse detection for button replacement)

### II.9. The difference between the mentioned sensor

Table II.3. summarizes the different techniques between the vibration sensors presented above

**Table II.3:** Comparison between Accelerometer sensors

Feature	ADXL335	MPU 6050	LIS3DH	MMA8452Q
Range	3g	16g	$\pm 2g, \pm 4G, \pm 6g, \pm 8G$ and $\pm 16g$	$\pm 2 g/\pm 4 g/\pm 8 g$
Resolution	10-bit	16-bit	12-bit and 10-bit	12-bit and 8-bit
Power-Consumption	330 $\mu$ A	1.39mA	2 $\mu$ A	6 $\mu$ A to 165 $\mu$ A
Sampling Rate	50Hz	1-8kHz	1.344kHz with 10bit resolution	25 Hz
Output Interface	Analog	Digital (1024byte FIFO buffer)	I <sup>2</sup> C/SPI digital output interface	I <sup>2</sup> C digital output interface
Output Data Rate	100Hz	100Hz	1 Hz to 5.3 kHz	1.56 Hz to 800 Hz

### II.10. Advantages & Disadvantages of Different Types of Vibration Sensors

#### II.10.1. Accelerometers

Accelerometers are excellent sensors for rolling element bearing and gear fault detection, or just about any faults that are in the mid- to high-frequency range – including short duration

impacts. They are also great for detecting unbalance, misalignment, bent shaft, loose or broken parts, component resonances, etc. Accelerometers are the most common sensor used in vibration monitoring applications. They offer a large frequency range and have a long-life expectancy (>20 years). They are available in small sizes, application-specific designs, and high temperature units [9].

### **II.10.2. Velocity Sensors**

Velocity sensors are easy to install, and are great for general vibration measurement and monitoring on rotating and reciprocating machinery. They are not sensitive to the surface to which they are mounted, they are used for medium frequency measurements, and they provide a good temperature range. Velocity sensors are electrodynamic, which means they self-generate their signal – so they require no power supply [9].

Velocity sensors, however, do have their disadvantages. They are more expensive than most accelerometers and they are limited in their life span – as the spring (membrane) where the internal magnet of the sensor is suspended will eventually wear out. They have an upper frequency limit as well as a lower resonance frequency due to resonance of the spring/mass, which limits its frequency range. Velocity sensors are also not suitable for early bearing detection, are sensitive to magnetic fields, they are slightly large in size, and their springs can deform over time [9].

### **II.10.3. Displacement Sensors**

Displacement sensors, also called a proximity probe or Eddy current probe, are non-contact sensors that measure displacement directly and are used to monitor shaft motion and internal clearances. They are the best option to monitor machines with journal and axial thrust bearings, and provide a good signal strength at low frequencies. Displacement sensors are reliable and are excellent for protection and monitoring of turbo machinery – regardless of the speed. Displacement sensors have their disadvantages as well. They are permanently mounted sensors and expensive to install. Displacement sensors are very sensitive to surface material composition and condition and they require a fixed cable length from Eddy probe to oscillator/demodulator [9].

## **II.11. Conclusion**

Vibration sensors are an essential tool for industrial maintenance as they can help identify potential problems before they become more serious and costly. By monitoring the vibration levels of machinery and equipment, maintenance teams can detect issues such as imbalance, misalignment, or wear and tear.

Vibration sensors can be used in a variety of industrial applications, including manufacturing plants, power generation facilities, and transportation infrastructure. They can also be integrated into condition monitoring systems, which allow maintenance teams to track the health of equipment and predict potential failures.

Overall, the use of vibration sensors in industrial maintenance can help improve the reliability and efficiency of equipment, reduce downtime, and ultimately save companies money in repair and replacement costs.

# **Chapter III**

## **Data collector test and analysis**



### III.1. Introduction

Data collection is a critical process in many fields, from scientific research to industrial automation. A data collector is a device that is used to gather information from sensors or other sources and store it for later analysis.

Realization and experimentation of a data collector typically involves the design and implementation of a hardware and software system that can interface with one or more sensors and collect data at a specified rate. The design of such a system may involve selecting an appropriate sensor for the application, designing the sensor interface circuitry, selecting a microcontroller or other computing platform to handle data acquisition and storage, and designing the data storage and retrieval system.

With the increasing availability of low-cost sensors and microcontrollers, it is now easier than ever to design and implement custom data collection systems that can provide valuable insights into a wide range of phenomena.

### III.2. Operation project mechanism

In this project, we will implement a low-cost data collection system using readily available sensors in the market and a precise microcontroller. The aim of this system is to measure and monitor vibrations by measuring acceleration in terms of vibrations, collecting data from the acceleration sensors, and displaying it on a user interface developed using the Python language. The signal will be converted from the time domain to the frequency domain using Fourier transformation.

This project is divided into two parts. The first part explains the hardware and installation, while the second part focuses on the software used to integrate the system

### III.3. Materials part

In this section, we will discuss some important concepts about the hardware used in creating this mini data collector project, as well as how to use, install and utilize its features.

#### III.3.1. Arduino Uno

Arduino Uno is a microcontroller board based on the ATmega328P (datasheet). It has 14 digital input/output pins (of which 6 can be used as PWM outputs), 6 analog inputs, a 16 MHz ceramic resonator (CSTCE16M0V53-R0), a USB connection, a power jack, an ICSP header and a reset button. It contains everything needed to support the microcontroller; simply connect it to a computer with a USB cable or power it with a AC-to-DC adapter or battery to get started. You can tinker with your Uno without worrying too much about doing something wrong, worst-case scenario you can replace the chip for a few dollars and start over again.

"Uno" means one in Italian and was chosen to mark the release of Arduino Software (IDE) 1.0. The Uno board and version 1.0 of Arduino Software (IDE) were the reference versions of Arduino, now evolved to newer releases. The Uno board is the first in a series of USB Arduino boards, and the reference model for the Arduino platform; for an extensive list of current, past or outdated boards see the Arduino index of boards [16].

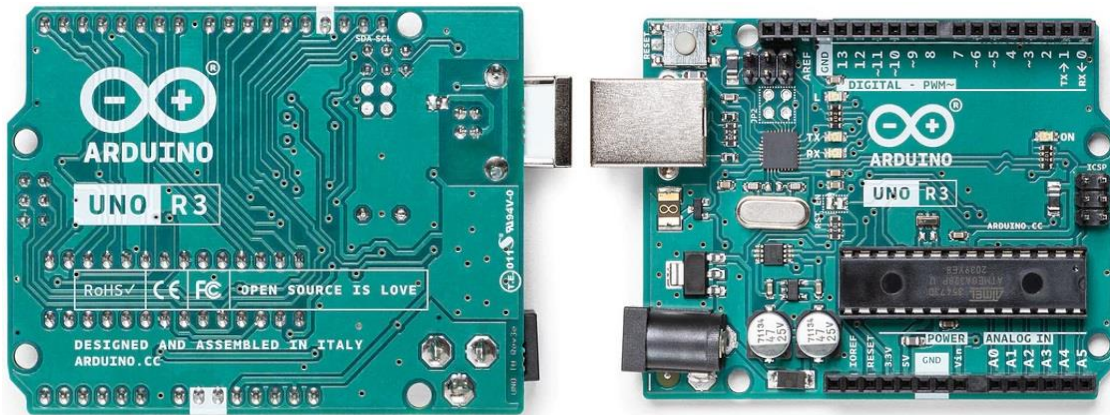

**Figure III.1:** Arduino Uno.

**Table III.1.** Specifications Arduino Uno board

<b>Microcontroller</b>	ATmega328P
<b>Operating Voltage</b>	5V
<b>Input Voltage (recommended)</b>	7-12V
<b>Input Voltage (limit)</b>	6-20V
<b>Digital I/O Pins</b>	14 (of which 6 provide PWM output)
<b>PWM Digital I/O Pins</b>	6
<b>Analog Input Pins</b>	6
<b>DC Current per I/O Pin</b>	20 Ma
<b>DC Current for 3.3V Pin</b>	50 Ma
<b>Flash Memory</b>	32 KB of which 0.5 KB used by bootloader
<b>SRAM</b>	2 KB (ATmega328P)
<b>EEPROM</b>	1 KB (ATmega328P)
<b>Clock Speed</b>	16 MHz
<b>LED_BUILTIN</b>	13
<b>Length</b>	68.6 mm
<b>Width</b>	53.4 mm
<b>Weight</b>	25 g

### III.3.2. Model installation plan

This model is a technical system consisting of several electronic components that aims to monitor and measure vibration. These elements are microcontroller (**ARDUINO UNO**), two acceleration sensors (**ADXL-335**, **MPU-6050**) 100ohm resistors for protection, a **restart button**, and finally a **PC**. The first sensor is connected to the Arduino through its three ports (**X.Y.Z**) with connecting wires to the analog inputs (**A0, A1, A2**) of the Arduino with resistors and two ports for ground and power As for the second sensor, it is also connected via its ports to the analog inputs (**A4, A5**) of Arduino with the two resistors and the last two ports to power and ground Also, don't forget the push button, which is connected to the entrance to the reboot .As for the Arduino, it is connected to the **PC** via a **USB** port

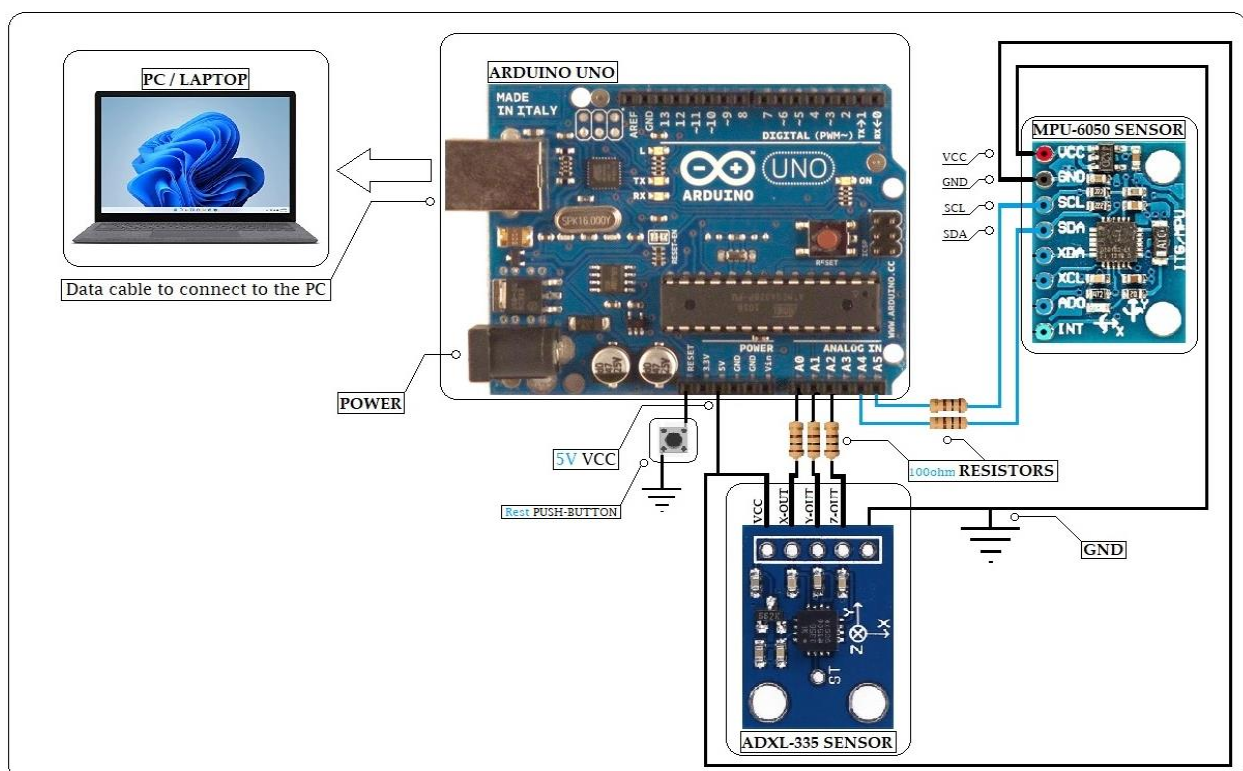

**Figure III.2:** Technical diagram for the system operation.

### III.3.3. System working principal

The system works on collecting data or signals received from the sensors and transmitting them to the **ARDUINO**. After processing the data, the microcontroller then sends the information to a computer for further analysis. The computer then runs diagnostics on the data and produces a result, which can be used to determine the condition of the machine and whether any maintenance or repairs are necessary.

Overall, this system helps ensure that machines are running efficiently and can help prevent breakdowns or failures before they occur, leading to cost savings and improved productivity.

### III.4. Software Part

To continue working on the project, we need several important software programs that work on assembling and organizing the electronic components mentioned earlier. This software is:

#### III.4.1. Arduino IDE

The Arduino Integrated Development Environment - or Arduino Software (**IDE**) - contains a text editor for writing code, a message area, a text console, a toolbar with buttons for common functions and a series of menus. It connects to the Arduino hardware to upload programs and communicate with them.

#### III.4.2. Python

Python is a high-level, interpreted, and object-oriented programming language that has dynamic semantics. It is known for its simplicity, readability, and ease of use, making it popular for rapid application development and as a scripting language. Python's built-in data structures and dynamic typing allow for code reuse and program modularity. Its extensive standard library is available for free on all major platforms. Python's quick edit-test-debug cycle, debugging features, and introspective power make it a favorite among developers, and adding print statements to the source is often an effective way to debug programs.

#### III.4.3. Fast Fourier Transform

The "Fast Fourier Transform" (FFT) is an important measurement method in the science of acoustics and vibrations measurement. It converts a signal into individual spectral components and thereby provides frequency information about the signal.

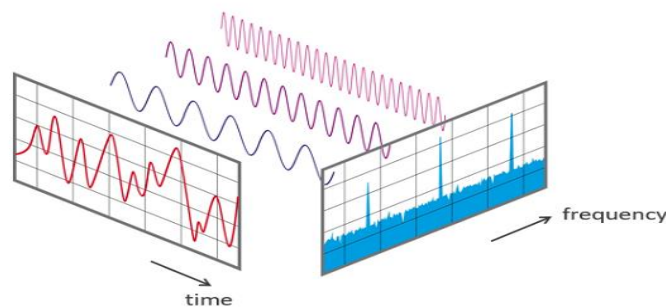

**Figure III.3:** Fourier Transform from Time Domain to Frequency Domain.

#### III.4.4. Serial Analyser

Serial analyser is an open-source user interface program developed in Python language that is used for reading, displaying, analyzing, and converting serial data from time domain to frequency domain using fast Fourier transform (FFT) algorithm.

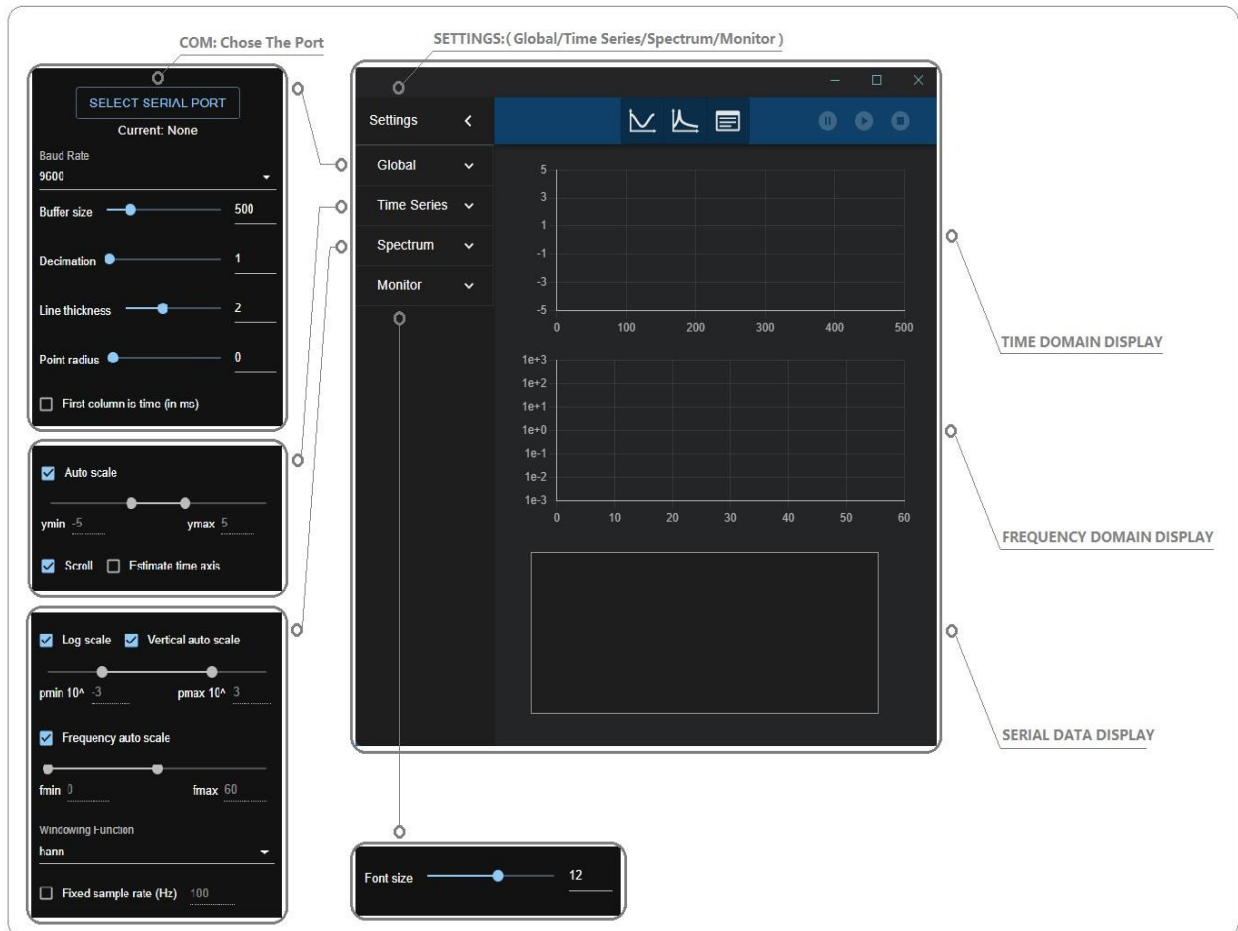

Figure III.4: Serial Analyser Settings

### III.4.5. Software programs working principal

#### III.4.5.1. Arduino code

First, we program the Arduino using its own code environment **Arduino IDE** with the following code.

```

1. //-----MPU6050
2. #include <MPU6050_tockn.h>
3. #include <Wire.h>
4. MPU6050 mpu6050(Wire);
5. long timer = 0;
6. //-----ADXL-335
7. const int x_out = A0;
8. const int y_out = A1;
9. const int z_out = A2;
10. void setup() {
11.   Serial.begin(9600);
12.   Wire.begin();
13.   mpu6050.begin();

```

```

14. mpu6050.calcGyroOffsets(true);
15. }
16. void loop() {
17. //-----MPU6050
18. mpu6050.update();
19. double AccX = (mpu6050.getAccX()-0.10)*9.81;
20. double AccY = mpu6050.getAccY()*9.81;
21. double AccZ = (mpu6050.getAccZ()+1.29)*9.81;
22. if(millis() - timer > 1000){
23. Serial.println(AccX);
24. Serial.println(AccY);
25. Serial.println(AccZ);
26. timer = millis();
27. }
28. //-----ADXL-335
29. int x_adc_value, y_adc_value, z_adc_value;
30. double x_g_value, y_g_value, z_g_value;
31. x_adc_value = analogRead(x_out);
32. y_adc_value = analogRead(y_out);
33. z_adc_value = analogRead(z_out);
34. x_g_value = (((((double)(x_adc_value * 5)/1024) - 1.65 ) / 0.330 ) * 9.18);
35. y_g_value = (((((double)(y_adc_value * 5)/1024) - 1.65 ) / 0.330 ) * 9.18);
36. z_g_value = (((((double)(z_adc_value * 5)/1024) - 1.80 ) / 0.330 ) * 9.18);
37. Serial.println(x_g_value);
38. Serial.println(y_g_value);
39. Serial.println(z_g_value);
40. delay(500);

```

#### III.4.5.2. Interfacing Arduino card with the analyser toolbox

Secondly, write a code to read data from Arduino on the user interface of **python**.

```

1. import serial
2. ser = serial.Serial('COM3', 9600) # Replace 'COM3' with the appropriate serial port name
   and 9600 with the appropriate baud rate
3. while True:
4. line = ser.readline().decode('utf-8').rstrip() # Read a line of data from the serial port and
   decode it from bytes to string
5. if line:
6. print(line) # Print the line of data to the console

```

### III.4.5.3. Fast Fourier Transformation

Then, we create a program to convert the signal from the time domain to the frequency domain using Fourier transformation (**FFT**) and using the Python language

```
1. import numpy as np
2. import matplotlib.pyplot as plt
3. from scipy import pi
4. from scipy.fftpack import fft
5. sample_rate = 1024
6. N = (2 - 0) * sample_rate
7. time = np.linspace(0, 2, N)
8. freq1 = 60
9. magnitude1 = 25
10. freq2 = 270
11. magnitude2 = 2
12. waveform1 = magnitude1 * np.sin (2 * pi * freq1 * time)
13. waveform2 = magnitude2 * np.sin (2 * pi * freq2 * time)
14. noise = np.random.normal (0, 3, N)
15. time_data = waveform1 + waveform2 + noise
16. plt.plot (time [0:100], time_data [0:100])
17. plt.title ("Time Domain Signal")
18. plt.xlabel ("Time")
19. plt.ylabel ('Amplitude')
20. plt.show ()
21. frequency = np.linspace (0.0, 512, int (N/2))
22. freq_data = fft(time_data)
23. y = 2/N * np.abs (freq_data [0:np.int (N/2)])
24. plt.plot(frequency, y)
25. plt.title('Frequency domain Signal')
26. plt.xlabel('Frequency in Hz')
27. plt.ylabel('Amplitude')
28. plt.show()
```

### III.5. Testing and experimentation of the project

After finishing assembling the parts, as well as writing the programming codes needed for this project, we start the process of testing the collector and due to the complexity of the experiments, we preferred to choose a simple system to test the device on it. For that the experimental phase is done on a water pump with the following specifications (370W power, 220V/50Hz voltage, 2.5 A current consumption, and 2800 rpm rotation speed),

### III.5.1. Time domain ADXL-335 vs MPU6050

Before going to the frequency domain, we try to compare the data collected from the two sensor for the time domain, we know that in the vibration analysis, the time domain can't give important information allow the engineer to make the right diagnostic. but in our case, we will focus on the exported data from the collector.

#### III.5.1.1 Measurement on X Axis

Figure III.5 shows the acceleration measured on x axis by the two sensors, note that the position on which the collector is installed into the pump is very important because each failure has a specific axe.

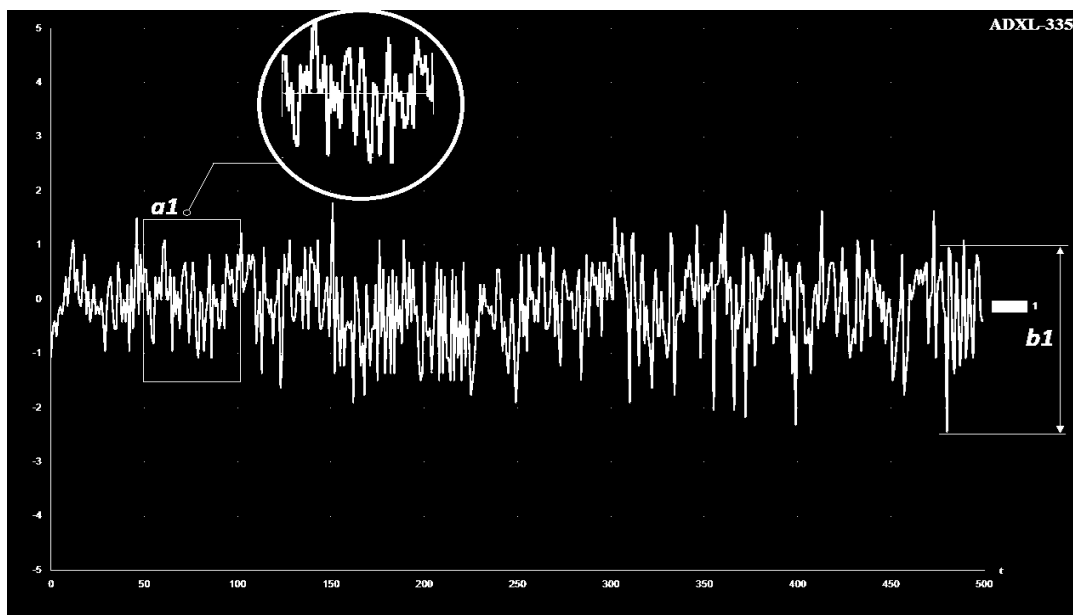

a) X Axe for ADXL-335

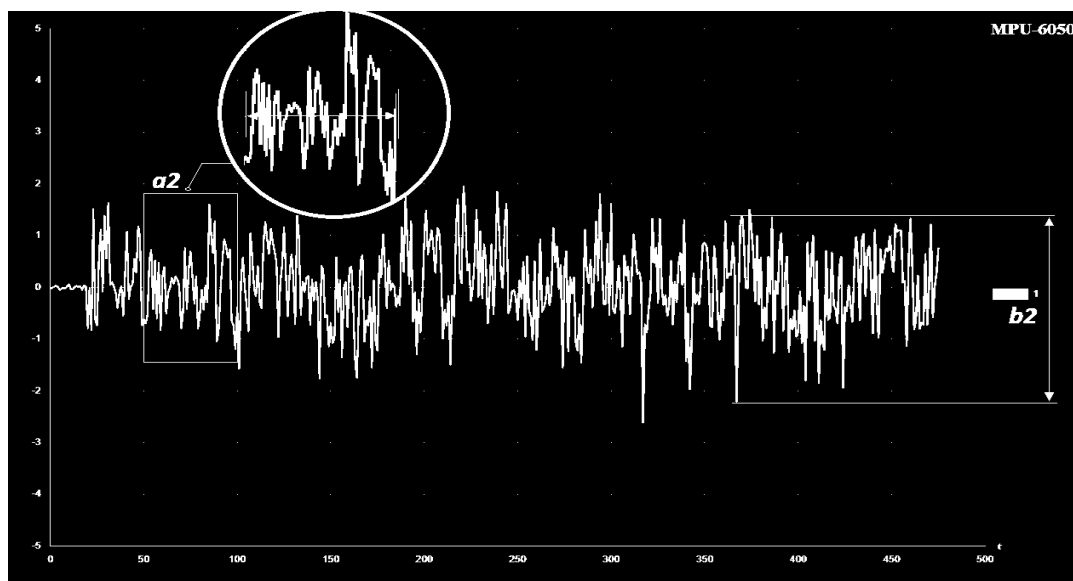

b) X Axe for MPU6050

**Figure III.5:** Measurement on X Axe Time domain ADXL-335 vs MPU6050



- **Comments**

According to the obtained results by measuring the acceleration on the x axis in the time domain, we note that the mpu6050 sensor had a wide measurement range compared to the adxl-335 sensor according to the following samples (a1 a2 and b1, b2) on Figure III.5 a and b respectively. As for the amount of data and response speed, the adxl-335 sensor has its performance is better, as we note the delay of the MPU6050 in absorbing data on the time domain according to the following samples (), but these remain the results on X axis only

### III.5.1.2 Measurement on Y Axis

Figure III.6 shows the acceleration measured on Y axis by the two sensors:

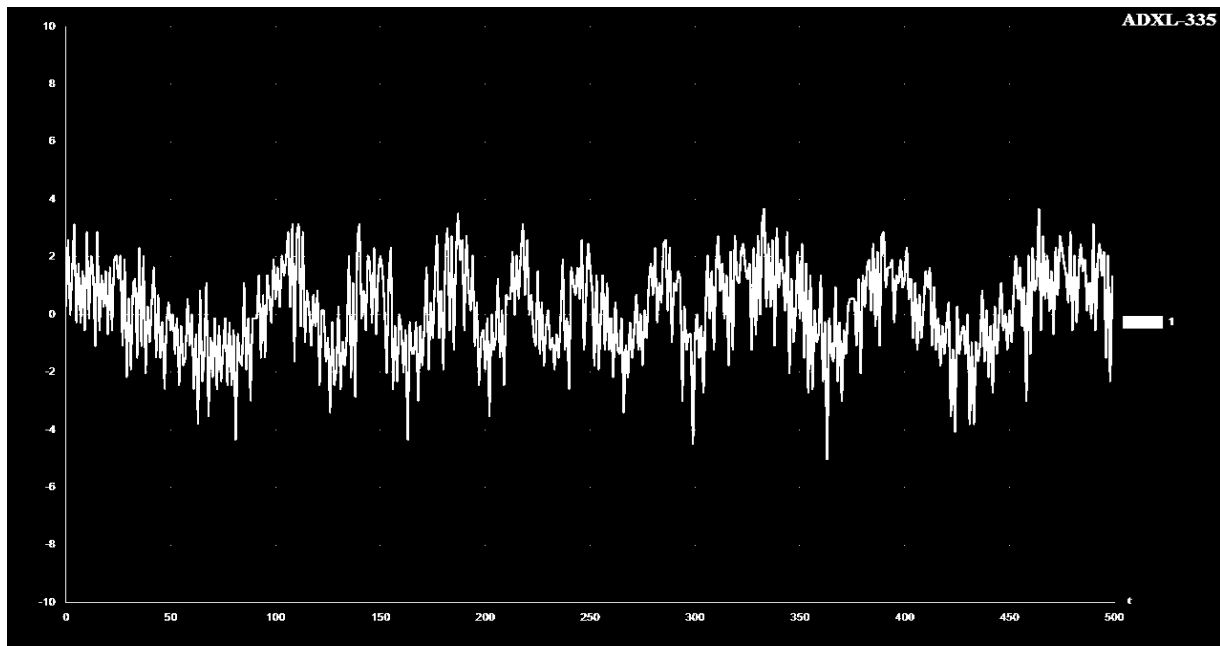

a) ADXL-335

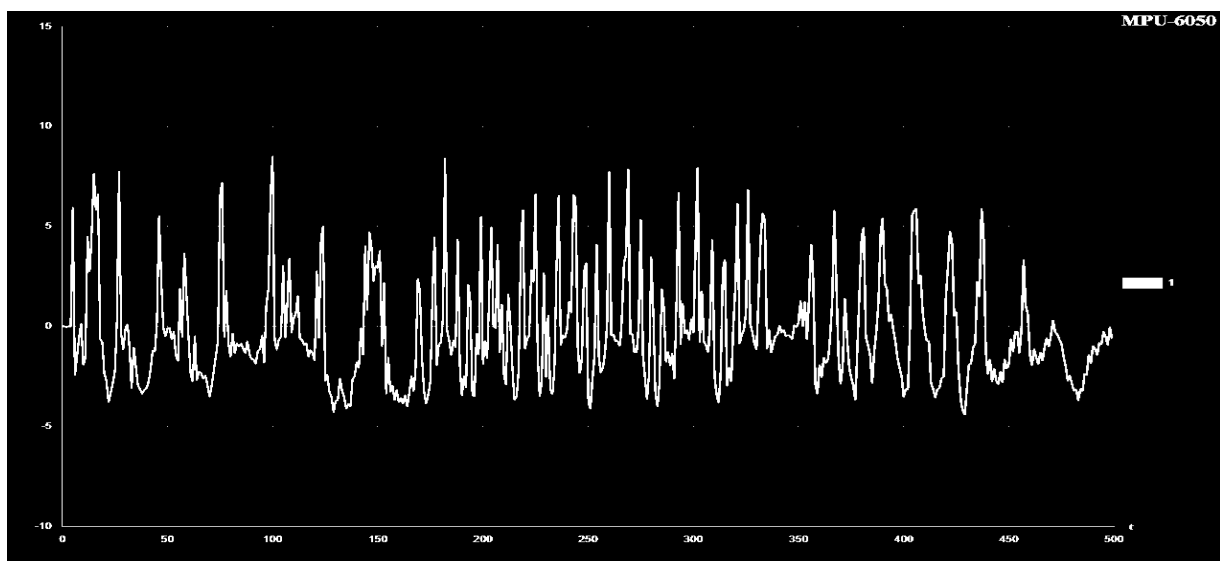

b) MPU6050

**Figure III.6:** Measurement on Y Axe Time domain ADXL-335 vs MPU605

- **Comments**

Based on the results of the second experiment and by measuring on the Y-axis in the time domain, we observe once again that the MPU6050 sensor had a wider measurement range compared to the ADXL-335 sensor, according to the following Figure III.6. However, in terms of data quantity and response speed, the ADXL-335 sensor exhibits better performance and stability with the assistance of the computer.

Nevertheless, using both sensors together can provide optimal utilization of the capabilities of both sensors in the time domain.

### III.5.1.3 Measurement on Z Axis

The measurement on Z axis is one of important data can give a significant result in detecting failure by marking what we called the frequency signature as well to make the difference between the two sensors. Keeping the collector in the same position, figure III.7 shows the acceleration on this axis.

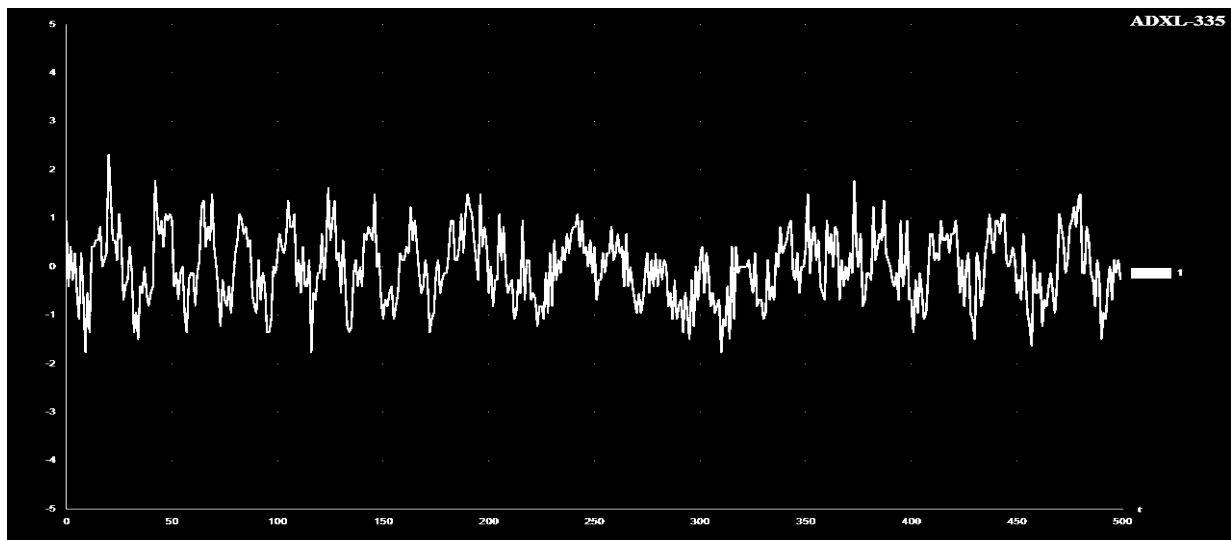

a) ADXL-335

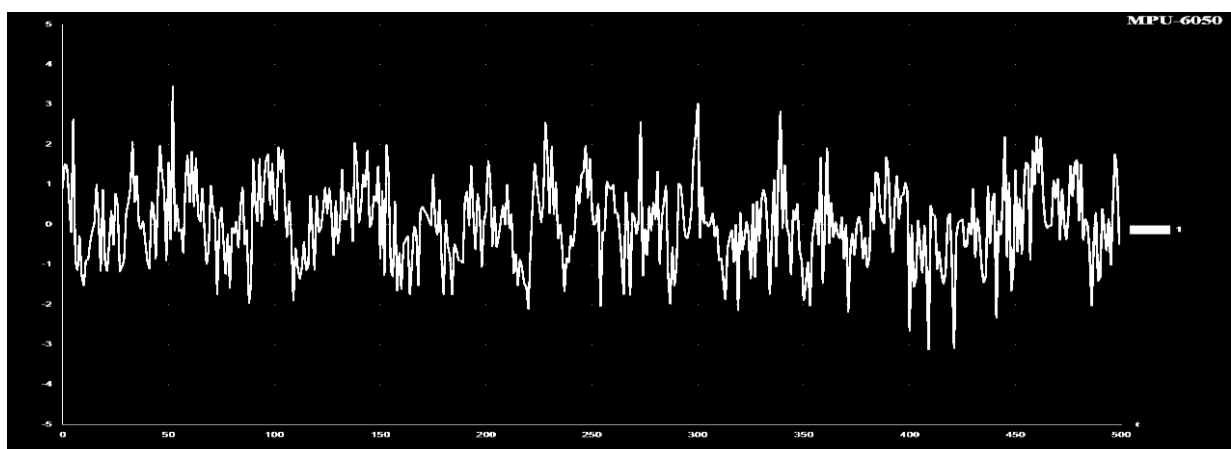

b) MPU6050

**Figure III.7:** Measurement on Z Axe Time domain ADXL-335 vs MPU6050

- **Comments**

During the measurement on the Z-axis, the results of the third experiment in the time domain indicate that the MPU6050 sensor proves to provide a much better and more stable measurement range compared to the ADXL-335 sensor, according to the following figure III.7. However, in terms of data quantity and response speed, the ADXL-335 sensor shows better performance with the assistance of the computer.

### III.5.2. Frequency domain ADXL-335 vs MPU6050

Where the time domain gives us an initial idea about the collector working and the performance on each sensor used in this last one, the vibration analysis as mentioned in chapter one is based on the frequency domain analysis.

For that, we return each experience in the time domain and using the FFT method, we transform the signal in the frequency domain to extract more information about the performance of the sensors.

#### III.5.2.1 Measurement on X Axis

For starting, figure III.8 shows the acceleration data on axis X extracted by the collector using the two sensors.

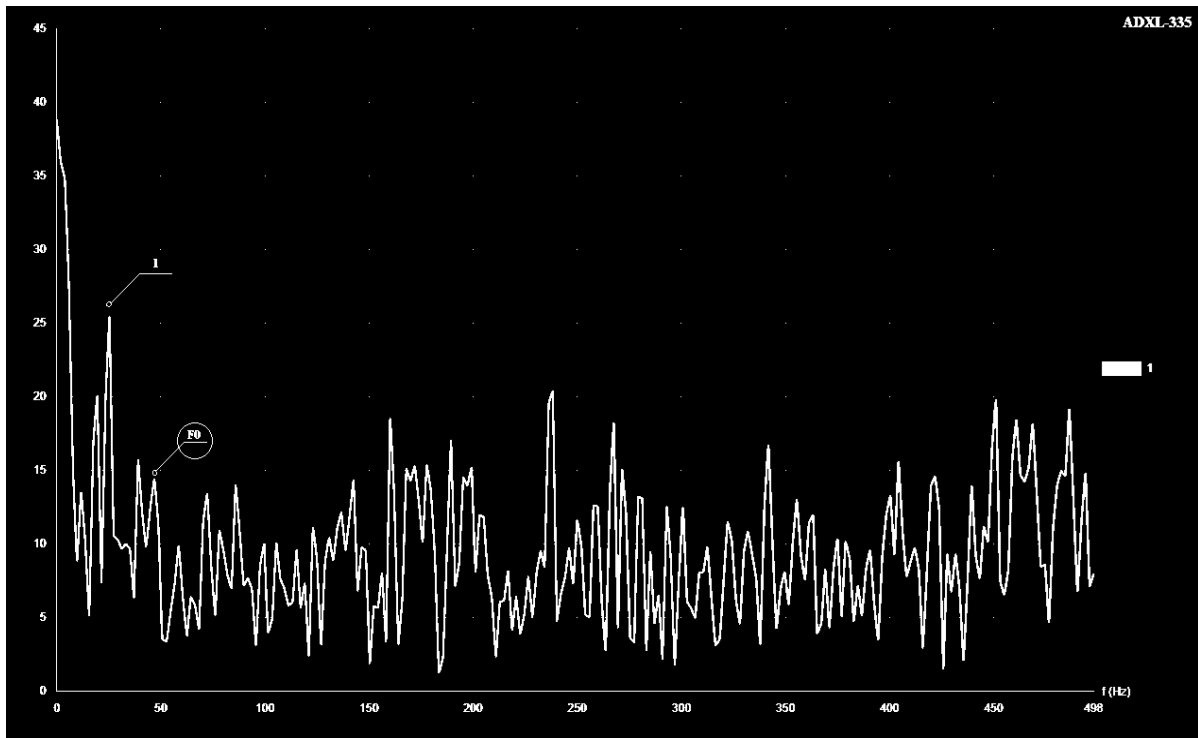

a) ADXL-335

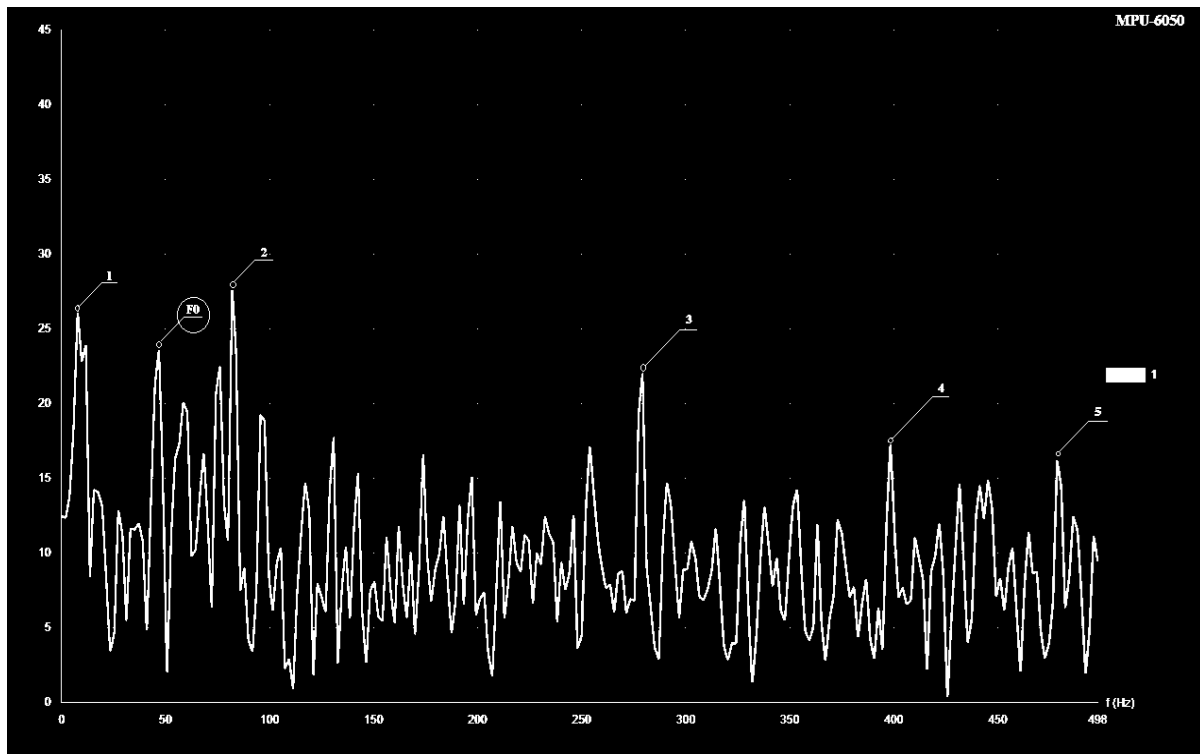

b) MPU6050

**Figure III.8:** Measurement on X Axis Frequency domain ADXL-335 vs MPU6050

- **Comments**

After conducting the first test in the frequency domain for column X, we observe that the sample rate of the frequency is higher for the MPU6050 sensor, which provides more detailed information and helps us analyse this data more accurately.

As for the error rate, it was lower compared to the ADXL-335 sensor, according to F0 (water pump frequency = 48hz), where the results were closer and had a higher measurement range. We significantly notice the superiority of the MPU6050 sensor.

### III.5.2.2 Measurement on Y Axis

On X axis, the analysis of obtained results show that the MPU6050 has more performance in the frequency domain, to validate this important remark, we test the collector saving the same position and characteristics on axis Y.

The acceleration signal obtained from the collector are shown in figure III.9.a for ADXL335 and III.9.b for MPU6050 respectively.

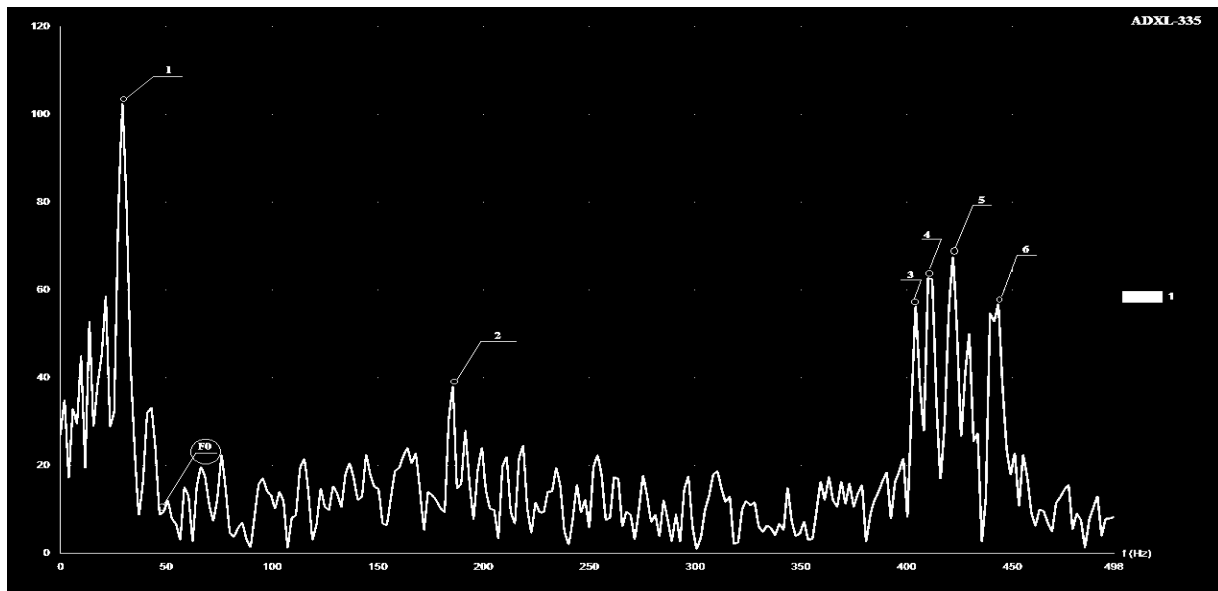

a) ADXL 335

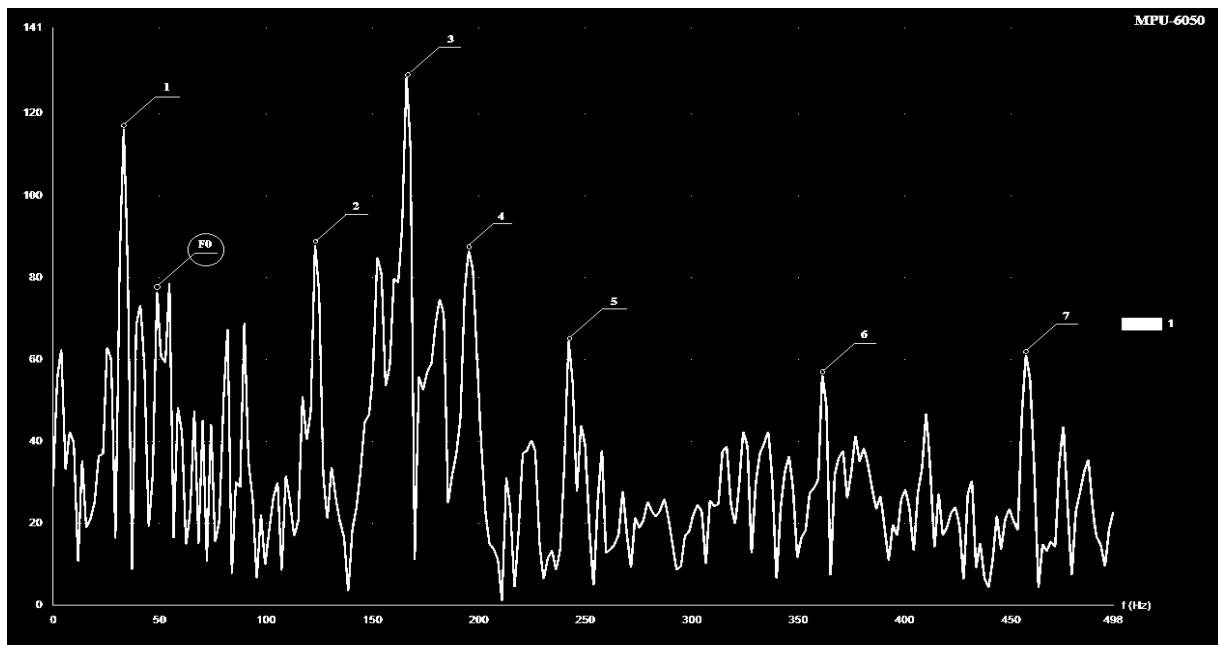

b) MPU6050

**Figure III.9:** Measurement on Y Axe Frequency domain ADXL-335 vs MPU6050

- **Comment**

On the axis Y, we observe consistent results with the first test in the frequency domain for axis X. We notice that the sample rate of the frequency has improved for the ADXL-335 sensor, but the MPU6050 sensor still had the highest sample rate. Additionally, the error rate is lower for the MPU6050 sensor compared to the ADXL-335 sensor, according to frequency 0 (water pump frequency), and a higher measurement range. We also note the superiority of the MPU6050 sensor

## III.5.2.3 Measurement on Z Axe

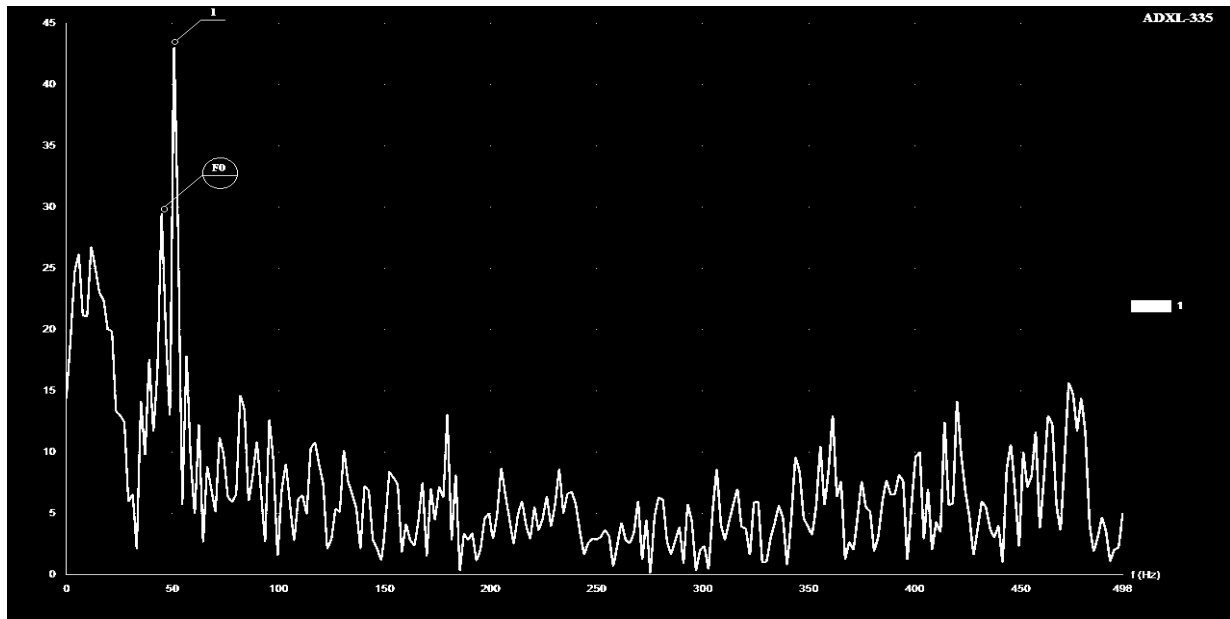

a) ADXL-335

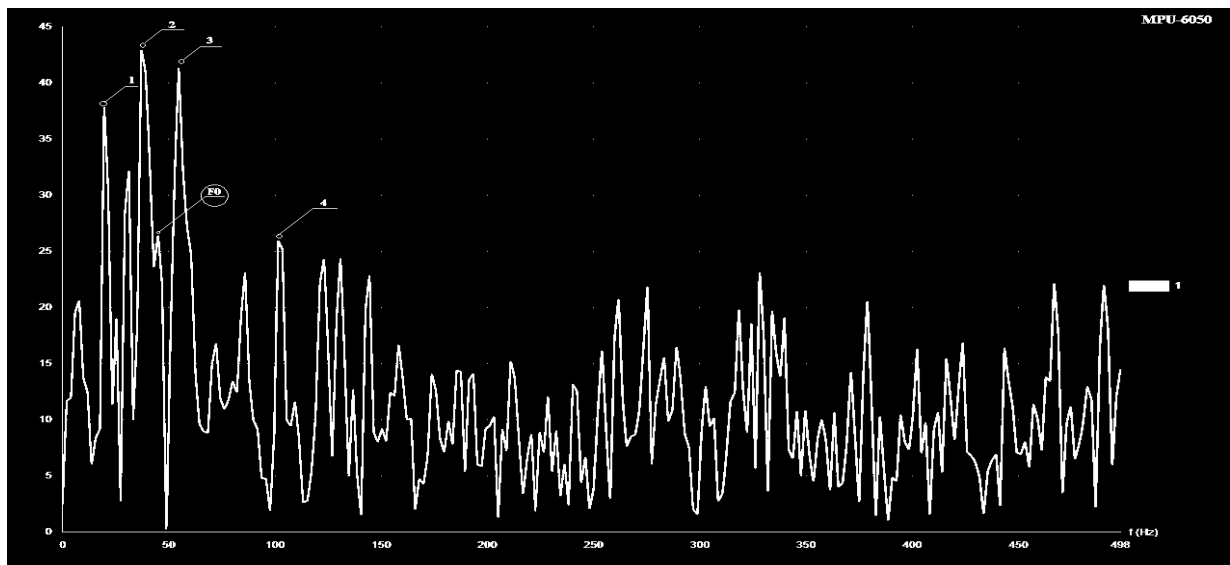

b) MPU6050

**Figure III.10:** Measurement on Z Axe Frequency domain ADXL-335 vs MPU6050

- **Comments**

As for axis Z, we observe consistent results with previous tests in the frequency domain. The sample rate of the frequency has improved for the ADXL-335 sensor, but the MPU6050 sensor consistently maintains a higher sample rate. Additionally, the MPU6050 sensor exhibits a lower error rate compared to the ADXL-335 sensor and offers a wider measurement range. Therefore, the MPU6050 sensor continues to outperform the ADXL-335 sensor

## III.6. General discussion and results

### III.6.1. Discussion

We observed several things and encountered several difficulties due to our limited experience in this field. However, with effort and dedication, we were able to achieve our goal through comparing and discussing the results obtained in the initial phase for both the ADXL335 and MPU6050 accelerometers. Let's compare these two sensors based on several factors:

1. **Measurement Range:** The ADXL335 has a measurement range of  $\pm 3$  g (gravity) in three axes (X, Y, Z), while the MPU6050 has a measurement range of  $\pm 2$ g,  $\pm 4$ g,  $\pm 8$ g, or  $\pm 16$ g, which can be configured. The MPU6050 provides a wider range of options for different applications.

2. **Sensitivity:** The ADXL335 has a sensitivity of 330 mV/g, meaning it produces an electrical voltage of 330 mV per gram of acceleration. The sensitivity of the MPU6050 can be adjusted based on the specified measurement range. It offers higher accuracy and more precise sensitivity adjustment.

3. **Interface:** Both sensors can be connected using digital interfaces such as I2C or SPI. The MPU6050 also provides an additional digital motion processing unit, which can perform complex calculations and motion data filtering on the chip, reducing the computational load on the main controller.

4. **Power Consumption:** The power consumption of the ADXL335 is relatively low, making it suitable for battery-operated applications. The MPU6050 consumes slightly more power due to the additional features it includes.

5. **Error Rate:** For the ADXL335, the typical sensitivity deviation is about  $\pm 10\%$  of the measured acceleration range. The offset error can reach up to  $\pm 50$  mg (milligrams), and the noise level is typically around  $300 \mu\text{g}/\sqrt{\text{Hz}}$ . As for the MPU6050, its typical sensitivity deviation is about  $\pm 2\%$  of the measured acceleration range. The offset error can reach up to  $\pm 40$  mg, and the noise level is usually around  $300 \mu\text{g}/\sqrt{\text{Hz}}$ . It is important to note that these values are approximate and provided as general guidelines. Higher accuracy can be achieved through calibration techniques and temperature compensation methods.

6. **Stability:** Both the ADXL335 and MPU6050 sensors exhibit a certain level of drift, which can be influenced by factors such as temperature changes, power supply stability, and sensor aging. However, specific stability characteristics may not be explicitly provided in the datasheets. Calibration techniques and temperature compensation methods can be employed to

mitigate drift and improve stability, reducing the impact of environmental factors and maintaining more stable measurements.

7. **Response speed:** the MPU6050 accelerometer sensor may have a faster and more accurate response compared to the ADXL335 sensor. This is due to the MPU6050 sensor's ability to capture precise changes in motion, thanks to its advanced technology and integration with a gyroscope sensor. The MPU6050 sensor provides a higher sampling rate and the ability to receive data more quickly, which improves responsiveness in detecting rapid motion changes compared to the ADXL335 sensor.

8. **Additional Features:** The ADXL335 is a basic accelerometer sensor and does not include additional features such as a gyroscope or temperature sensor. On the other hand, the MPU6050 includes a 3-axis gyroscope for measuring angular velocity and a temperature sensor. The MPU6050 offers more comprehensive motion sensing capabilities.

9. **Cost:** The ADXL335 model is generally more cost-effective compared to the MPU6050. If budget constraints are an important factor, ADXL335 might be a preferred choice.

### III.6.2. Results

Table III.1 summarize the obtained results that show the performance between the two sensors:

**Table III.1:** Comparison results between ADXL-335 and MPU6050

	ADXL-335	MPU6050
Measurement Range	<b>BAD</b>	<b>GOOD</b>
Sensitivity	<b>BAD</b>	<b>GOOD</b>
Interface	<b>BAD</b>	<b>GOOD</b>
Power Consumption:	<b>GOOD</b>	<b>BAD</b>
Error Rate	<b>BAD</b>	<b>GOOD</b>
Stability	<b>SAME</b>	<b>SAME</b>
Response speed	<b>BAD</b>	<b>GOOD</b>
Additional Features	<b>NON</b>	<b>YES</b>
Cost	<b>GOOD</b>	<b>BAD</b>



**III.7. Conclusion**

At the end of the project and based on previous experiments, it is evident that both sensors are designed for specific categories or fields. Therefore, the MPU6050 was found to be the better choice according to the obtained results compared to the ADXL-335. This is due to its physical characteristics that align better with the scope of our project.

In conclusion, the preferred sensor is the MPU6050 because it performs the required task, attracts higher signals, and has a higher sampling rate. This helps us to analyse the vibrations with more accurate manner, making it more suitable for the project (mini data collector).

**GENERAL  
CONCLUSION**

## **1- conclusion**

In conclusion, the development of a data collector for analyzing and monitoring vibrations has proven to be a valuable project. By comparing different sensors available on the market, we were able to select a suitable sensor that met our specific requirements.

The data collector successfully gathers vibration data, which can then be transmitted to a computer for further analysis. This allows for in-depth spectral analysis, providing valuable insights into the nature and characteristics of the vibrations.

The project has highlighted the importance of selecting the right sensor based on its specific characteristics and capabilities. By considering factors such as cost-effectiveness and performance, we were able to create a data collector that meets our needs while keeping expenses to a minimum.

Overall, the data collector provides a valuable tool for monitoring and analyzing vibrations. It has the potential to be utilized in various applications, such as industrial settings, structural health monitoring, and predictive maintenance. The insights gained from the analysis can aid in identifying potential issues, optimizing performance, and ensuring the safety and efficiency of machinery and structures.

Further enhancements and refinements can be made to the data collector in the future, such as adding additional features or improving data transmission capabilities. With continuous improvements and advancements, the data collector can become an even more powerful tool for vibration analysis and monitoring.

This project allowed us to apply our skills in sensor design and evaluation. We also learned how to optimize costs by selecting a sensor device that aligns with our specific needs.

In conclusion, thanks to this project, we succeeded in designing an efficient mini data collector for measuring and monitoring vibrations, while considering cost constraints.

## **2- Recommendations for future work**

The Vibrometer can also be optimized to provide advanced capabilities and intelligent analysis by merging AI technologies. Here's how a Vibrometer can use AI  
Data acquisition, Signal processing, Pattern recognition, Real time analysis, Diagnosis of defects, Predictive maintenance, Continuous learning and improvement

**Bibliography**

**References**

## ***Bibliography References***

- [1] Jack D. Peters, “Beginning Vibration Analysis with Basic Fundamentals”, CTC vibration Analysis Hardware, 2022.
- [2] B. Haym, M. Nagurka and S. Han, “Mechanical Vibration: Theory and Application”. Rutgers University Press. 2022.
- [3] S, Mohammed Hamed Ahmed. "Vibration Basics and Machine Reliability Simplified: A Practical Guide to Vibration Analysis." Zenodo. 2020.
- [4] “What Is Vibration Analysis and What Is It Used For?” Retrieved May 15, 2023 (<https://www.twi-global.com/technical-knowledge/faqs/vibration-analysis.aspx>).
- [5] Turner, R. C., P. A. Fuierer, R. E. Newnham, and T. R. ShROUT. “Materials for High Temperature Acoustic and Vibration Sensors: A Review.” Applied Acoustics 41(4):299–324. 1994
- [6] S. N. kumar, “Working Principle and Industrial Trends of Vibration Sensors.” AZoSensors.Com. Retrieved June 14, 2023 (<https://www.azosensors.com/article.aspx?ArticleID=2643>).
- [7] “Vibration Sensor Applications, Working, Types, and Selection – What Is Piping.” Retrieved May 15, 2023 (<https://whatispiping.com/vibration-sensors/>).
- [8] S. Rao, “Vibration Measurement and Applications”, Mechanical Vibrations 5th edition, September 2010.
- [9] “Vibration Sensors and Their Importance in Vibration Monitoring of Rotating and/or Reciprocating Machines.” <https://www.omega.com/en-us/>. Retrieved May 15, 2023 (<https://www.omega.com/en-us/resources/vibration-sensors-in-vibration-monitoring>).
- [10] Datasheet “MPU6050 Module Pinout, Configuration, Features, Arduino Interfacing & Datasheet.” Retrieved May 15, 2023 (<https://components101.com/sensors/mpu6050-module>).
- [11] “Complete Guide ADXL335 Accelerometer with Arduino Interfacing | S.” Retrieved May 15, 2023 (<https://www.electronicwings.com/sensors-modules/adxl335-accelerometer-module>).
- [12] “ADXL335 3-Axis Accelerometer Module.” Retrieved May 15, 2023 (<https://www.circuits-diy.com/adxl335-3-axis-accelerometer-module/>).

[13] MEMS digital output motion sensor: ultra-low-power high-performance 3-axis "nano" accelerometer Datasheet - production data

[14] "Documentation - MATLAB & Simulink." Retrieved June 14, 2023 (<https://www.mathworks.com/help/tic2000/ref/lis3dhaccelerometersensor.html>)

[15] MMA8452Q, 3-axis, 12-bit/8-bit digital accelerometer Datasheet

[16] "Arduino Uno Rev3." Arduino Official Store. Retrieved May 15, 2023 (<https://store.arduino.cc/products/arduino-uno-rev3>).

[17] yarn electron: start "Curiores/Serial Analyzer."  
(<https://github.com/curiores/SerialAnalyzer>) 2023-06-02 19:07

## الملخص

في هذا المشروع، عملنا على تصميم مسجل بيانات صغير بناءً على مقارنة أجريناها بين أجهزة الاستشعار المتوفرة في السوق. كان الغرض من ذلك هو إنشاء جهاز لقياس الاهتزازات ومراقبتها يجمع البيانات ويرسلها إلى جهاز كمبيوتر لإجراء تحليل طيفي أكثر تعمقًا وبأقل تكلفة. تم الاختيار على أساس خصائص كل جهاز استشعار. الاختبار تم على مستشعرين هما ADXL335 و MPU6050 وهذا لتوفرهما في السوق و لقلّة سعرهما و خلال التجارب لاحظنا تفوق ال MPU6050 في ما يتعلق بالنقاط الاهتزازات و هو ما يسهل استعماله لتتبع فشل الآلات

**الكلمات المفتاحية:** تحليل الاهتزاز، فشل الآلات، ADXL335 ، MPU6050

## Abstract

In this project, we designed a small data logger based on a comparison of sensors available in the market. The purpose was to create a device for measuring and monitoring vibrations that would collect data and send it to a computer for more in-depth spectral analysis at the lowest cost. The selection was made on the basis of the characteristics of each sensor. The test was carried out on two sensors, ADXL335 and MPU6050, due to their availability in the market and their low price. During the experiments, we noticed the superiority of the MPU6050 in terms of capturing vibrations, which is what makes it easier to use to track the failure of machines.

**Keywords:** Vibration analysis, failure, ADXL335, MPU650

## Résumé

Dans ce projet, nous avons conçu un petit enregistreur de données basé sur une comparaison des capteurs disponibles sur le marché. L'objectif était de créer un appareil de mesure et de surveillance des vibrations qui collecterait des données et les enverrait à un ordinateur pour une analyse spectrale plus approfondie à moindre coût. La sélection a été faite sur la base des caractéristiques de chaque capteur.

Le test a été réalisé sur deux capteurs, ADXL335 et MPU6050, en raison de leur disponibilité sur le marché et de leur faible prix. Lors des expérimentations, nous avons remarqué la supériorité du MPU6050 en termes de captation des vibrations, ce qui facilite son utilisation pour le suivi des pannes des machines.

**Mots clés :** Analyse vibratoire, panne, ADXL335, MPU650